

---

# THE PRODUCT CATALOGUE

---

Der Mineralwerkstoff, um Räume neu zu denken.

The solid surface material for rethinking spaces.

---

GETACORE®



---

# Contents

- 4. Features and Benefits
  
- 10. Rethinking Spaces
  
- 18. Dekore/Decors
  - 18. Colour Palette
  - 20. Uni White/Cream
  - 22. Uni Grey/Black
  - 24. Uni Colour
  - 26. Frosted
  - 27. Concrete
  - 28. Miracle
  - 30. Terrazzo
  - 32. Veneto
  
- 34. 3Deep
  
- 36. Produkte/Products
  - 36. Smart
  - 38. Optimal
  - 40. Classic
  - 41. 3Deep
  - 42. Arbeitsplatten/Worktops
  - 44. Verbundelemente/Compound elements
  - 46. Elementezubehör/Accessories for elements
  - 48. Fugenklebstoff/Adhesive
  - 50. Zubehör/Accessories
  - 53. Zuschnitt/Cut-to-size
  
- 54. Spülen und Becken/Sinks and Basins
  - 56. Küchenspülen/Kitchen sinks
  - 60. Sanitärbecken/Bathroom basins
  - 68. Beckenzubehör/Accessories for sinks and basins
  
- 70. Objektgeschäft/Custom solutions
  
- 72. Allgemeine Informationen/General Information
  - 72. Nachhaltigkeit/Sustainability
  - 74. RAL-/NCS-Zuordnung/RAL/NCS Allocation
  - 76. Anwendung und Pflege/Use and Care

# FEATURES AND BENEFITS

---

Mit unserem acrylgebundenen Mineralwerkstoff Getacore schaffen wir die Möglichkeit, Räume neu zu denken: Durch die Option, das Material extrem zu verformen, und optimale Plattenmaße lösen wir Grenzen in der Gestaltung auf. Eine breite Palette von Uni-Farbtönen bis hin zu lebendigen Designs ermöglicht es, die Wirkung und Nutzung von Räumen nachdrücklich zu prägen.

Hergestellt in Deutschland wird Getacore höchsten Qualitätsansprüchen gerecht: Seine Langlebigkeit, die hervorragende Farbkonstanz und die außergewöhnliche Formstabilität, die den Einsatz als Verbundelement ermöglicht, überzeugen nachhaltig. Deshalb geben wir auf Getacore eine Gewährleistung von 10 Jahren für Projekte, die von einem geschulten Partner installiert wurden.

With our acrylic-bonded solid surface material Getacore, we make it possible to rethink spaces. Through the extreme formability of the material and optimal sheet dimensions, we dissolve the limits of design. A broad palette ranging from plain colour shades to vibrant designs emphatically defines the effect and function of your space.

Manufactured in Germany, Getacore meets the highest quality standards: it offers long-term durability, outstanding colour consistency and extraordinary dimensional stability, which enables its use as a compound element. That's why we offer a 10-year warranty for Getacore, if installed by a trained partner.

---

# Made in Germany



Getacore wird nach höchsten europäischen Qualitäts- und Umweltstandards in Deutschland produziert. Von unserem Produktions- und Logistikzentrum im Herzen Europas aus können wir unseren Kunden auf kurzem Weg eine umfangreiche Bandbreite an Dekoren und Plattenmaßen zur Verfügung stellen. Unsere Experten beraten auch in unserem eigenen Schulungszentrum und unterstützen bei Projekten.

Getacore is produced in Germany in accordance with the highest European quality and environmental standards. From our production and logistics centre in the heart of Europe, we are able to provide customers with a comprehensive range of decors and panel sizes in close proximity. Our experts also give advice at our in-house training centre and support with projects.

# 3mm for Elements



Die Mineralwerkstoffplatten mit einer Dicke von nur 3 mm bieten eine hervorragende Formstabilität, Langlebigkeit und ein extrem geringes Schrumpfverhalten von 0,05 %. Das prädestiniert sie für den Einsatz als Arbeitsplatte oder Verbundelement. So können Projektkosten ohne Qualitätseinbußen gesenkt werden.

The solid surface material sheets with a thickness of only 3 mm offer exceptional dimensional stability, durability and extremely low shrink characteristics of only 0.05%. This makes them ideal for use as a worktop or compound element. As a result, project costs are reduced without compromising on quality.

# Batch to Batch



Getacore zeichnet sich vor allem durch seine überragende Farbkonstanz aus – und das über alle Chargen und verschiedene Dicken, Längen und Breiten hinweg. Die Farbpalette orientiert sich an den aktuellen Design-trends.

Getacore is characterised by its outstanding colour consistency – across all batches, as well as in different thicknesses, lengths and widths. The colour palette is based on the latest design trends.

# Perfect Size



Welche Größe es auch sein soll: Getacore passt. Mit einer Breite bis 1.250 mm und Länge bis 4.100 mm im Standardprogramm sinkt der Verschnitt sowie der Fugen- und Schleifaufwand.

Whichever size you need: Getacore fits. With a width of up to 1,250 mm and a length of up to 4,100 mm in the basic range, there is less need for cutting, joining and grinding.

Und wenn für größere Projekte ein Sondermaß benötigt wird? Dann gibt es das ideale Plattenmaß mit Längen von 1.800 bis 4.100 mm, Breiten von 650 bis 1.270 mm und Dicken von 3 bis 22 mm.

And if you need special dimensions for a larger project? Then the ideal panel size is available in a length of 1,800 to 4,100 mm, a width of 650 to 1,270 mm and a thickness of 3 to 22 mm.

## Smart (3 mm)

Geringerer Materialeinsatz bei Nutzung als Verbundelement

Less material necessary when used as a composite element

## Optimal (10 mm)

Gleiche Stabilität und Einsatzmöglichkeit wie Standarddicke 12 mm

Same stability and scope of application as standard thickness 12 mm

## Classic (6 & 12 mm)

Marktstandard für ein breites Feld an Anforderungen

Market standard for a wide range of requirements

# Easy

## Optisch fugenfreie Klebung

Optische Ruhe: Oberflächen und Elemente wie aus einem Guss lassen sich ohne sichtbare Fugen mit Getacore durch Kleben und anschließendes Schleifen herstellen.

## Erneuerbarkeit der Oberfläche

Schnell wieder wie neu: Kratzer und Gebrauchsspuren können unkompliziert weggeschliffen werden. Bei größeren Schadstellen kann das Material für das Auge unsichtbar ersetzt werden.

## Thermische Verformung

Ideal für individuelle Formen: Getacore bietet unendliche Gestaltungsmöglichkeiten. Mit der Weiterentwicklung 3Deep haben wir die Verformbarkeit maximiert.

## Porenfreie Oberfläche

Leicht zu reinigen: In Poren können sich schnell Schmutz und Bakterien sammeln. Die Oberfläche von Getacore ist komplett porenfrei und deshalb besonders hygienisch.

## Bonded without visible joints

Visual calm: with Getacore, surfaces and elements can be made to appear perfectly seamless, as if cast from a single piece, through bonding and subsequent grinding.

## Renewable finish

As good as new: scratches and traces of use can easily be polished away in no time. In case of more extensive damage, the material can be replaced without leaving a trace.

## Thermoforming

Ideal for individual shapes: Getacore offers endless design possibilities. We have maximised formability with the advanced development, 3Deep.

## Non-porous surface

Easy to clean: dirt and bacteria can easily accumulate in pores. That's why the surface of Getacore is completely non-porous and therefore particularly hygienic.



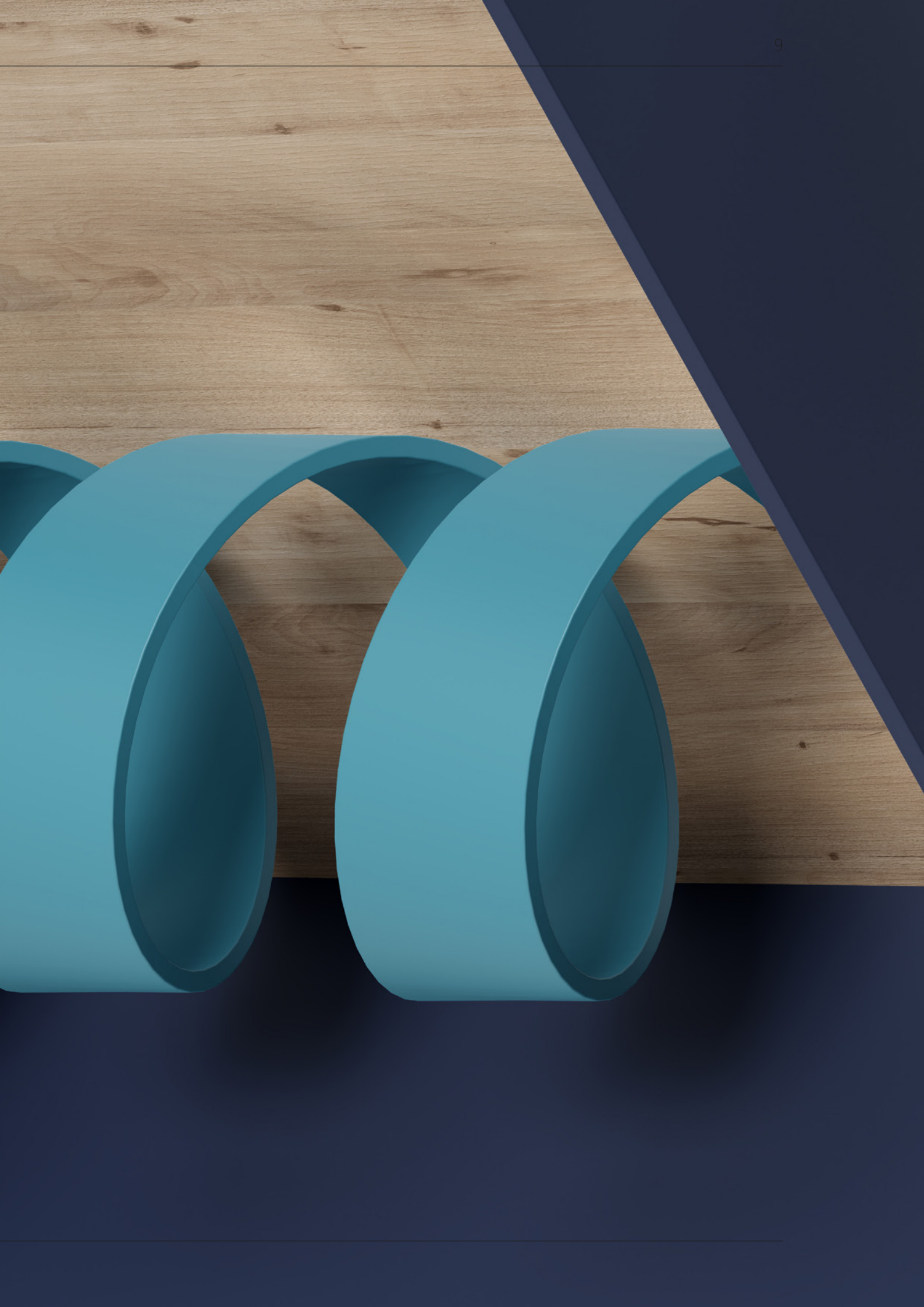

# RETHINKING SPACES

In Zeiten des Umbruchs braucht es einerseits Verlässlichkeit: eine hohe Produktqualität, persönlichen Service und Liefertreue. Andererseits sind Freiräume wichtig, um neue Wege gehen zu können. Getacore schafft diese durch seine außergewöhnliche Verformbarkeit und die breite Farbpalette, die um wohnliche Farben und ausdrucksstarke Terrazzo-Designs ergänzt wurde. Denn Wohnen, Arbeiten, aber auch die Frage nach allem, was dazwischen stattfindet, beeinflussen unser Sein und Empfinden. Die folgenden Seiten sollen deshalb inspirieren und eine Idee davon vermitteln, wie man Räume neu denken kann.

In times of great change, there are two factors required for success. The first is reliability: high product quality, personal service and the ability to deliver on time. The other is creative freedom – the scope to forge new paths. Getacore provides both these factors thanks to its extraordinary formability and wide range of colours, which now also include homely tones and expressive terrazzo designs. After all, the way we live, work and do everything in between has an impact on who we are and how we see the world. As such, we hope that the pages that follow will inspire you and give you ideas for how to rethink your space.

---

# Raum der Transformation

A transformative space

Was bringt die Menschen zurück ins Office? Es muss einen deutlichen Mehrwert bieten, Raum für Innovation und Dialog sein und eine Entfaltung des persönlichen Potenzials fördern, wie es das Büro zuhause nicht kann. Offene Strukturen, ein inspirierendes Design, eine Town-Hall-Atmosphäre, die zum Austausch einlädt – all das weitet die Perspektive für Einflüsse von außen und setzt Motivation und Kreativität frei.

What brings people back to the office? The office needs to offer tangible added value – to be a space for innovation and dialogue, where employees can develop their personal potential in a way that simply isn't possible when working from home. Open structures, an inspiring design, a town hall atmosphere that invites people to talk and discuss ideas – all of this opens the door to more outside influence, unlocking motivation and creativity.

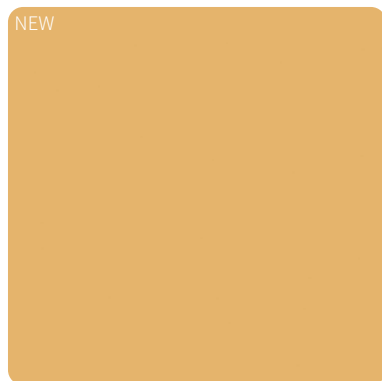

Limana Yellow | GC 9005



Ameti Purple | GC 8012





# Wirkt ganzheitlich – Gesundes Design

A holistic effect – Healthy design

Wohlbefinden herzustellen ist gerade im Health Care-Sektor essenziell. Die beruhigende Wirkung der Natur beeinflusst die Entscheidung für organische Formen, harmonische Töne und natürliche Materialien. Getacore bietet hier einen großen Spielraum in Form und Farbe, addiert jedoch als porenfreier Mineralwerkstoff einen extrem hohen Hygienestandard hinzu. Auch die fugenfreie Verarbeitung schenkt dem Auge Weite und vermittelt durch das Design die Ruhe, die es braucht, um zu genesen.

Establishing a sense of well-being is essential, especially in the healthcare sector. The calming effect of nature plays a key role in the decision to use organic shapes, harmonious tones and natural materials. Getacore offers a huge degree of creative freedom for these spaces in terms of shapes and colours, while also adding an extremely high standard of hygiene thanks to its non-porous mineral material. The joint-free fabrication also provides a sense of space, using the design to foster the calmness needed in order to heal.



Megara Green | GC 5012

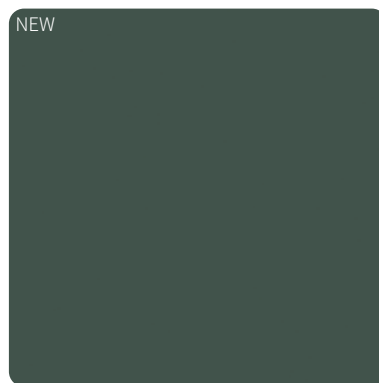

Vancouver Green | GC 5021

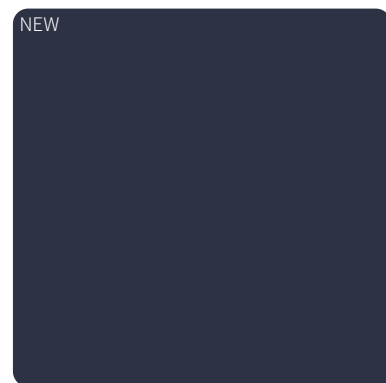

Tromso Blue | GC 8021

# Wenn aus Shopping Storytelling wird

When shopping becomes storytelling

Menschen haben nach wie vor ein großes Bedürfnis nach Erlebnissen, nach etwas Realem, Materialien zum Anfassen. Wer etwas zu erzählen hat, der hat etwas zu bieten, das online kaum zu vermitteln ist. So werden Stores zu Erlebnisräumen, aufgeladen mit einer eigenen Geschichte und einer ganz eigenen Formensprache. Nicht als Gegenspieler des Digitalen, sondern als erweiterte Erzählung.

There is still a great need for experiences that give people something real – something they can touch. Anyone who has a story to tell has something to offer that is almost impossible to replicate through online interaction. This approach turns stores into experience spaces brimming with their own stories and unique design language. Storied stores don't compete with digital offerings. They simply keep the narrative going.

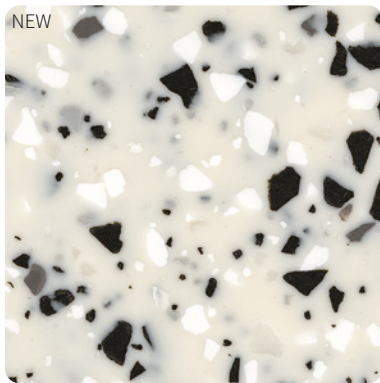

Terrazzo Dalmato | GCT 212

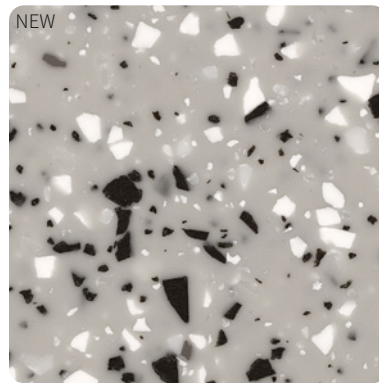

Terrazzo Artico | GCT 412

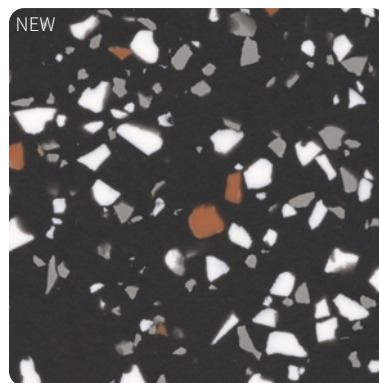

Terrazzo Nocturn | GCT 162

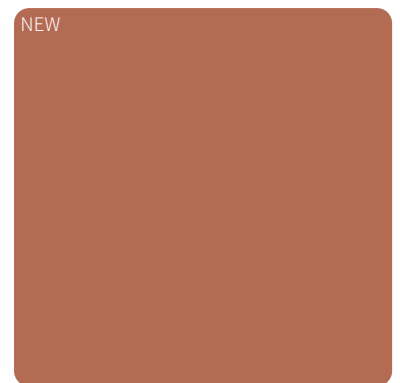

Haddou Red | GC 6010





# Colour Palette

Uni

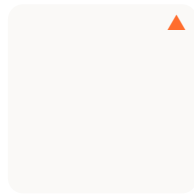

Titan White | GC 2011

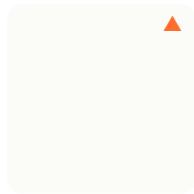

Davos White | GC 2008

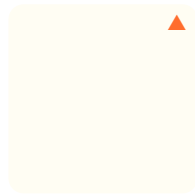

Dolomiti White | GC 2012

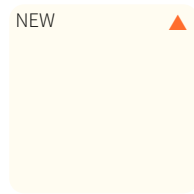

NEW

White Cloud | GC 2042

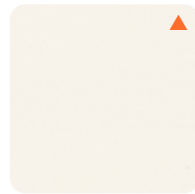

Cream White | GC 2002

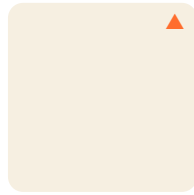

Trento White | GC 2003

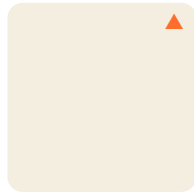

Pergamon | GC 2007

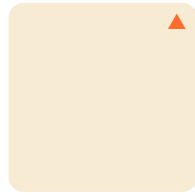

Merano Cream | GC 3011



Lugano Grey | GC 4012

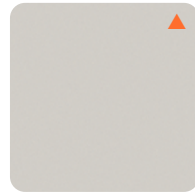

Soho Grey | GC 4022



Asphalt Grey | GC 4004



Riva Grey | GC 4010



Garda Grey | GC 4009



Tessino Grey | GC 4007



Ascona Grey | GC 1004

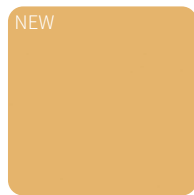

NEW

Limana Yellow | GC 9005



NEW

Haddou Red | GC 6010



NEW

Almeria Red | GC 6021

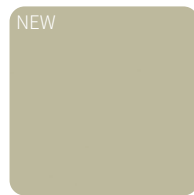

NEW

Megara Green | GC 5012

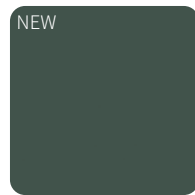

NEW

Vancouver Green | GC 5021



NEW

Ameti Purple | GC 8012



NEW

Norrebro Blue | GC 8010



NEW

Tromso Blue | GC 8021

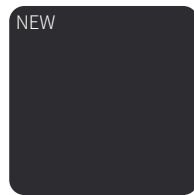

NEW

Black Eclipse | GC 1021



NEW

Vienna Black | GC 1001

## Oberflächenschliff

Auslieferungszustand: Nassschliff

Empfohlenes Endfinish: Seidenmatt/Brillantglanz

## Surface finish

Delivery version: Wet sanded

Recommended endfinish: SemiMat/HighGloss

## Frosted/Concrete



Frosted Cloud | GC 2269



Frosted Star | GC 2245

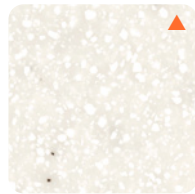

Frosted Carat | GC 2252

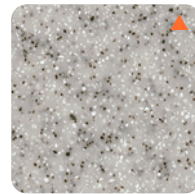

Frosted Dust | GC 4143

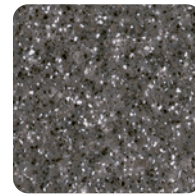

Frosted Grey | GC 4712

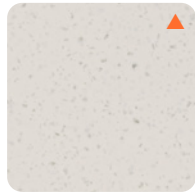

Concrete Lugano | GC 4412



Concrete Riva | GC 4410

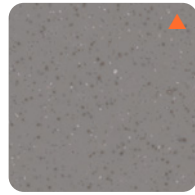

Concrete Garda | GC 4409



Concrete Tessino | GC 4407

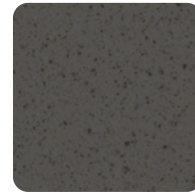

Concrete Ascona | GC 1104



Frosted Dark | GC 1122



Frosted Space | GC 1112

## Miracle

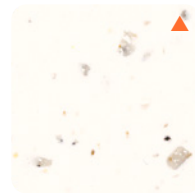

Miracle Beach | GC 2388

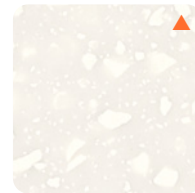

Miracle Rock | GC 2258



Miracle Vanilla | GC 3434



Miracle Dune | GC 3391

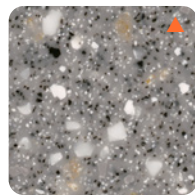

Miracle Granite | GC 4439

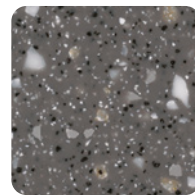

Miracle Flint | GC 4715

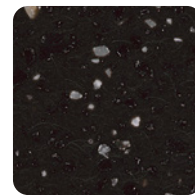

Miracle Stone | GC 1472

## Terrazzo

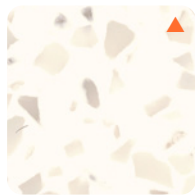

Terrazzo Crystal | GCT 236



Terrazzo Pebble | GCT 244

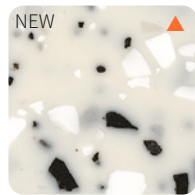

Terrazzo Dalmato | GCT 212



Terrazzo Artico | GCT 412

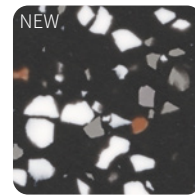

Terrazzo Nocturn | GCT 162

## Veneto

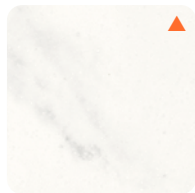

Marmo Sile | GCV 216

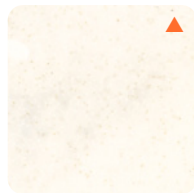

Marmo Padola | GCV 223

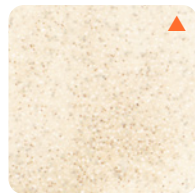

Marmo Brenta | GCV 374

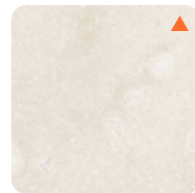

Marmo Piave | GCV 239

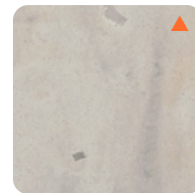

Marmo Livenza | GCV 478



Marmo Meduna | GCV 142

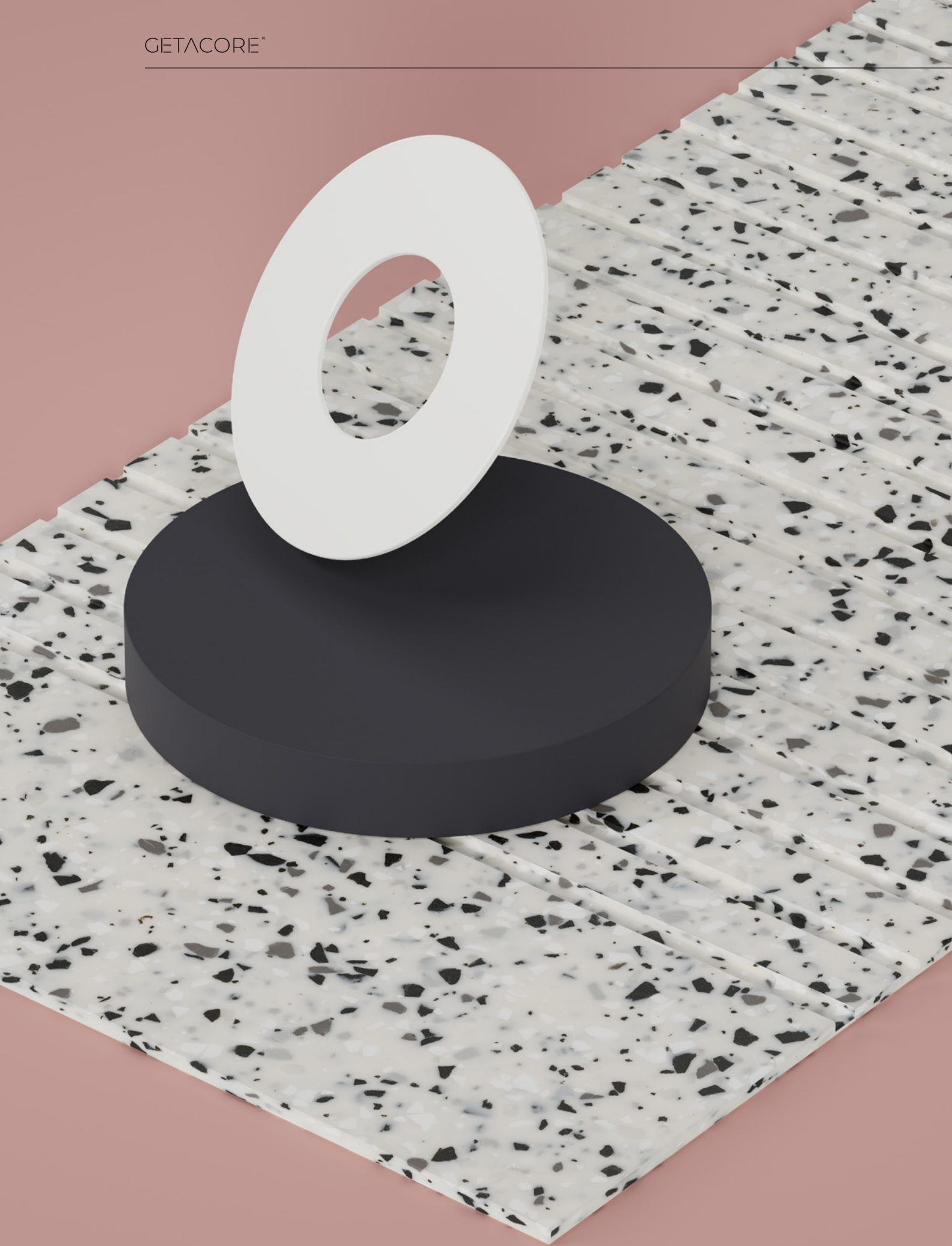

# Uni White/ Cream

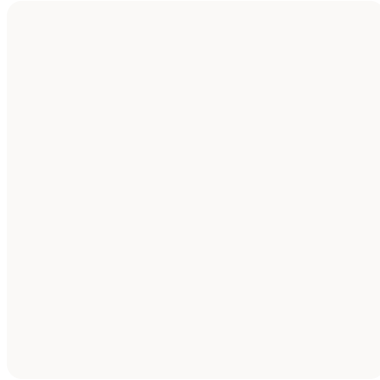

Titan White | GC 2011

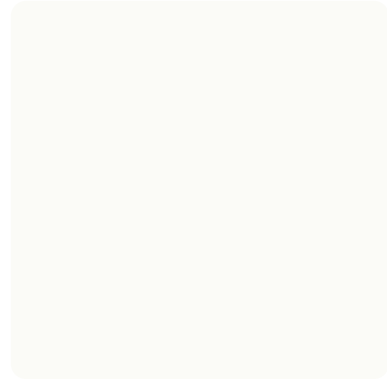

Davos White | GC 2008

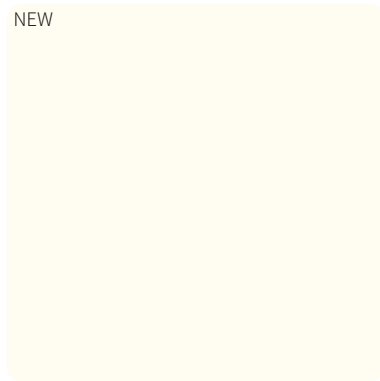

White Cloud | GC 2042



Dolomiti White | GC 2012

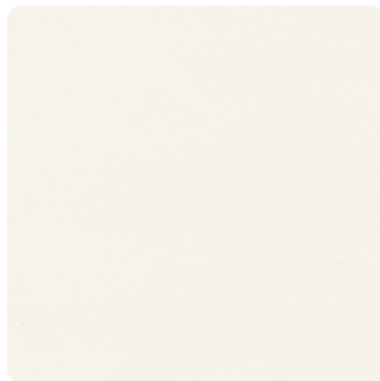

Cream White | GC 2002

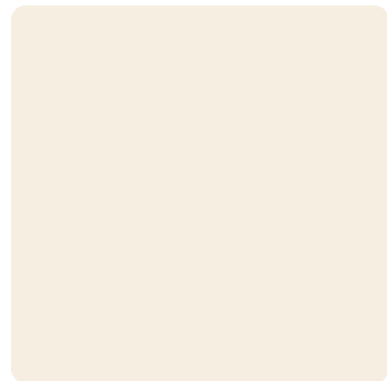

Trento White | GC 2003

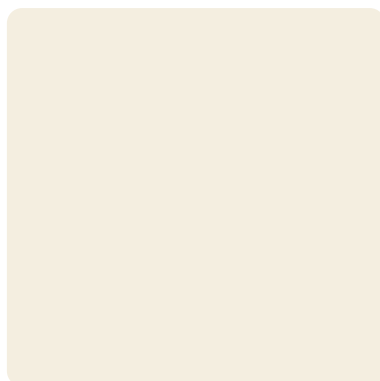

Pergamon | GC 2007

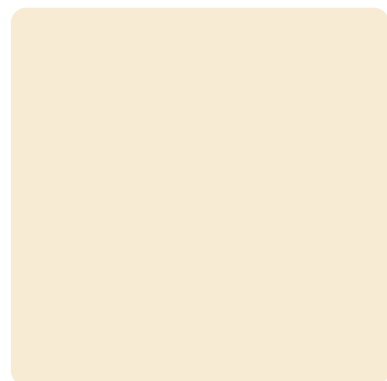

Merano Cream | GC 3011

# Uni Grey/Black

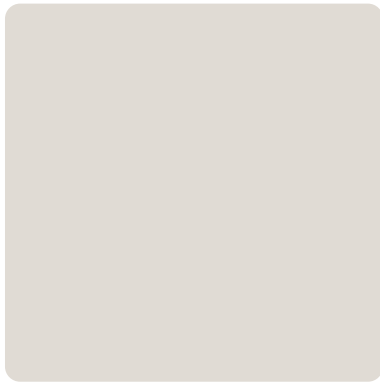

Lugano Grey | GC 4012



Soho Grey | GC 4022

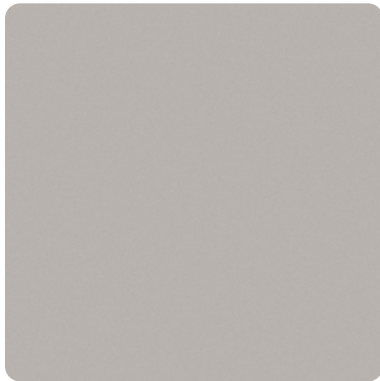

Asphalt Grey | GC 4004

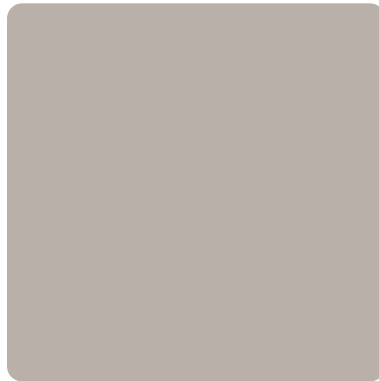

Riva Grey | GC 4010



Garda Grey | GC 4009



Tessino Grey | GC 4007



Ascona Grey | GC 1004

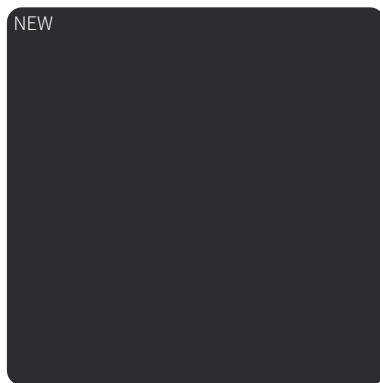

Black Eclipse | GC 1021



Vienna Black | GC 1001

# Uni Colour



Haddou Red | GC 6010

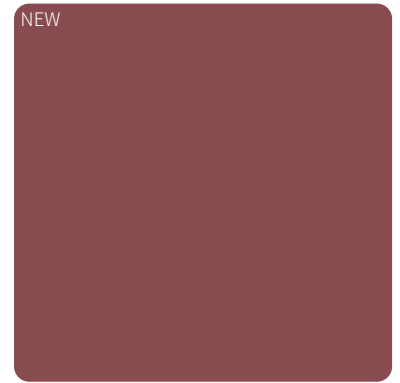

Almeria Red | GC 6021



Limana Yellow | GC 9005

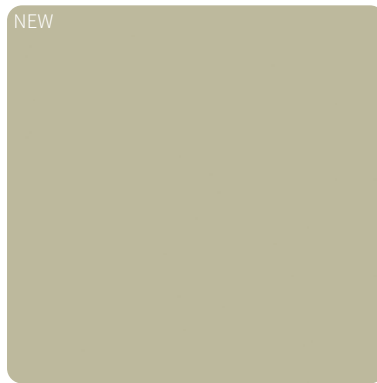

Megara Green | GC 5012



Vancouver Green | GC 5021

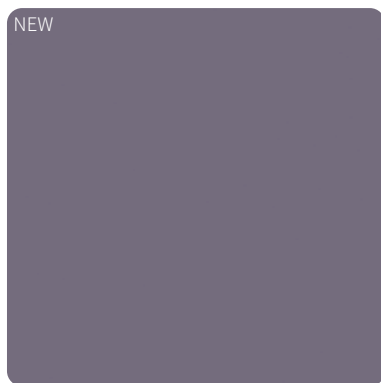

Ameti Purple | GC 8012

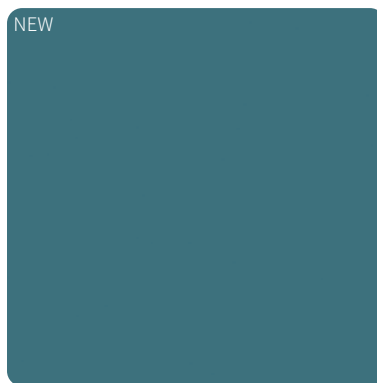

Norrebro Blue | GC 8010

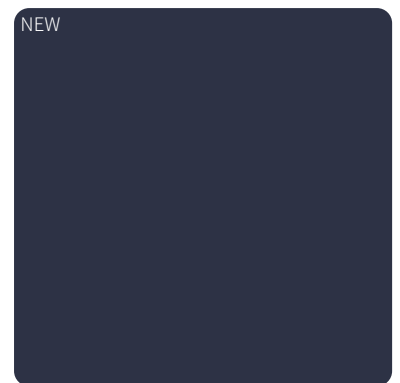

Tromso Blue | GC 8021

---



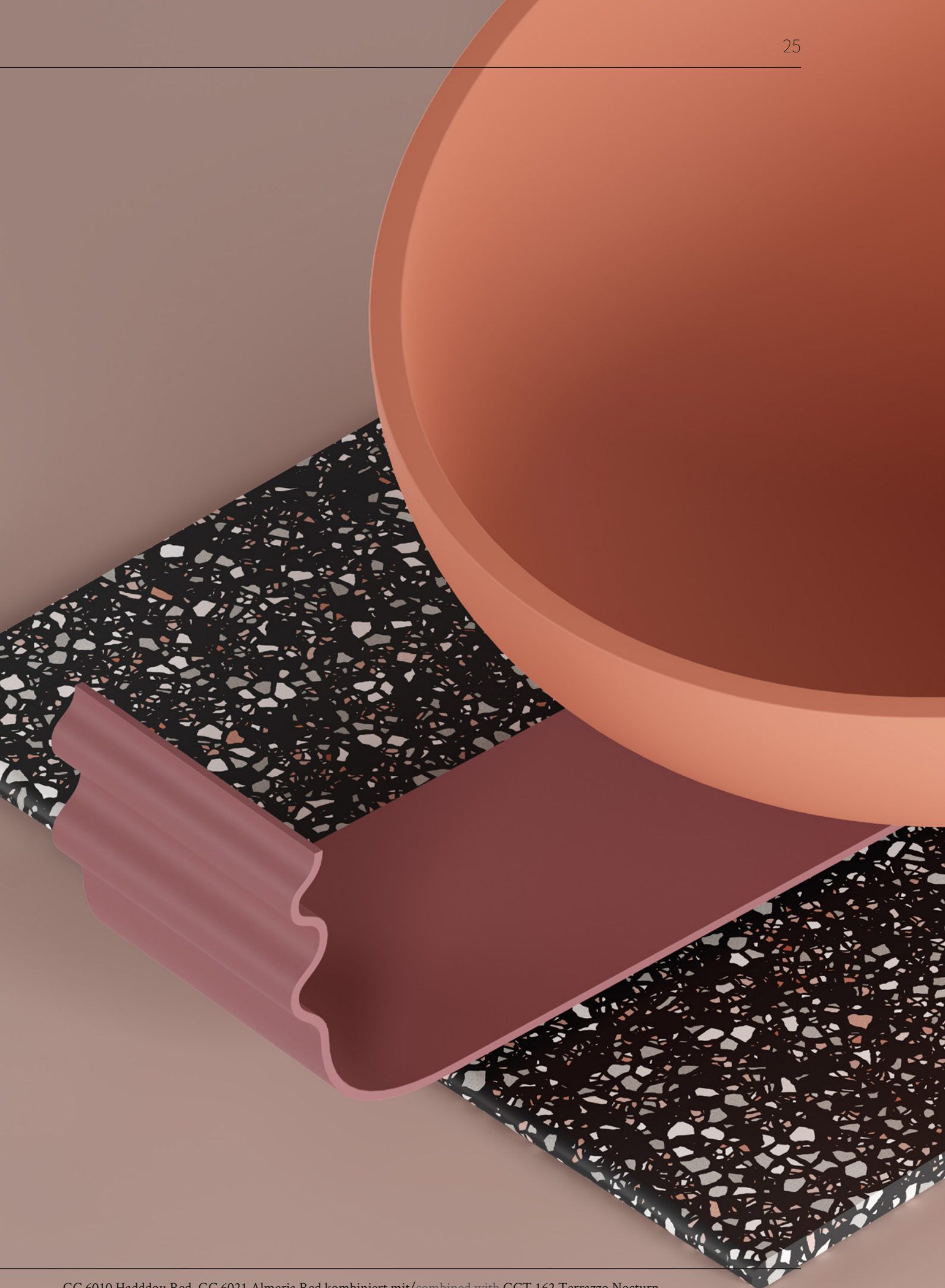

# Frosted



Frosted Star | GC 2245



Frosted Cloud | GC 2269

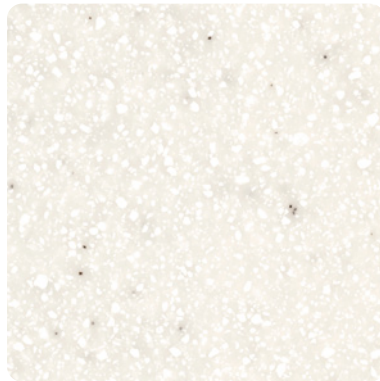

Frosted Carat | GC 2252



Frosted Dust | GC 4143

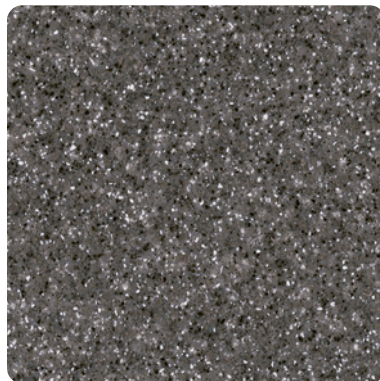

Frosted Grey | GC 4712



Frosted Dark | GC 1122



Frosted Space | GC 1112

---

# Concrete



Concrete Lugano | GC 4412

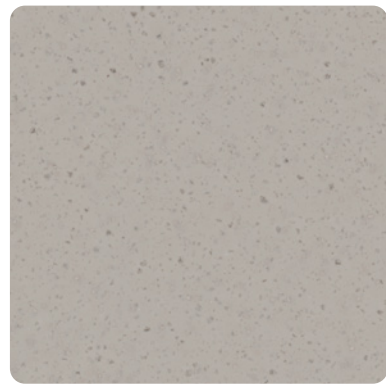

Concrete Riva | GC 4410



Concrete Tessino | GC 4407

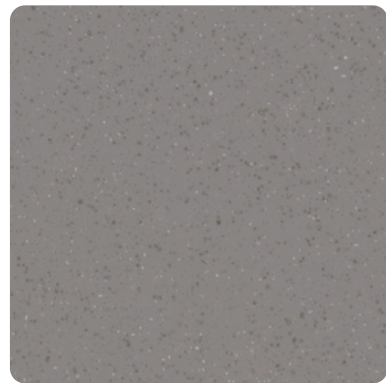

Concrete Garda | GC 4409



Concrete Ascona | GC 1104

# Miracle

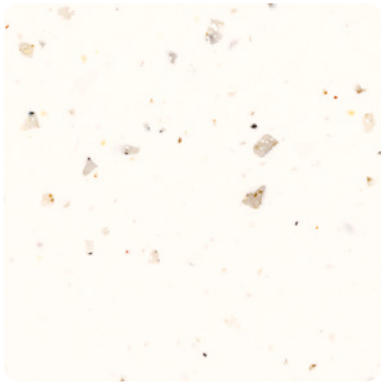

Miracle Beach | GC 2388



Miracle Rock | GC 2258

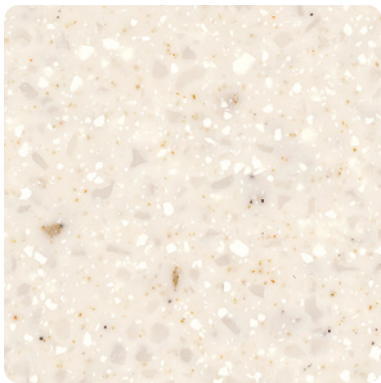

Miracle Vanilla | GC 3434

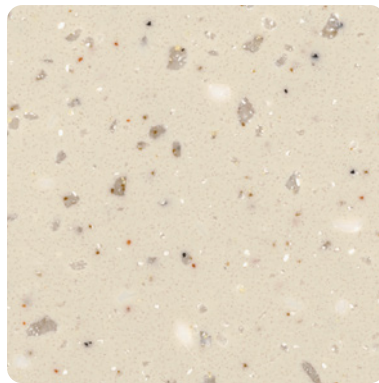

Miracle Dune | GC 3391

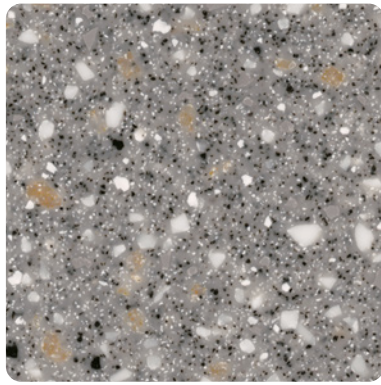

Miracle Granite | GC 4439

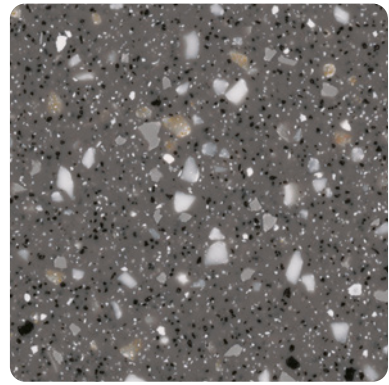

Miracle Flint | GC 4715

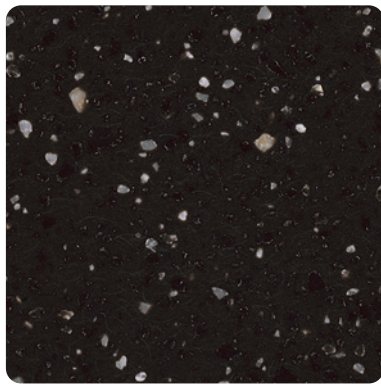

Miracle Stone | GC 1472



# Terrazzo



Terrazzo Crystal | GCT 236

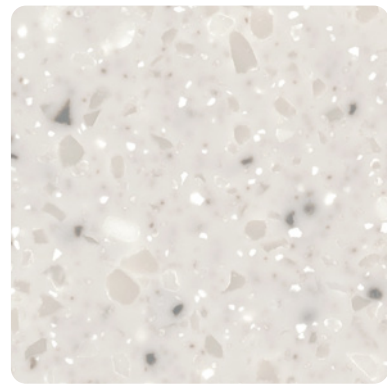

Terrazzo Pebble | GCT 244

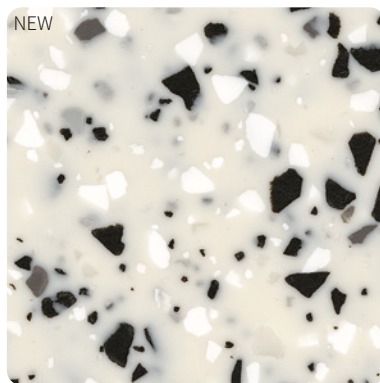

Terrazzo Dalmato | GCT 212

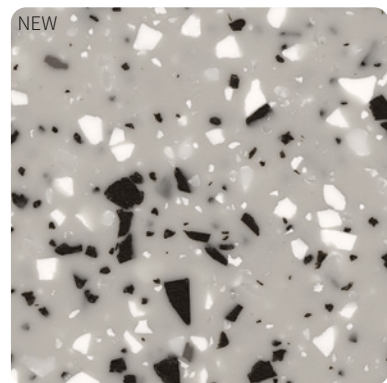

Terrazzo Artico | GCT 412

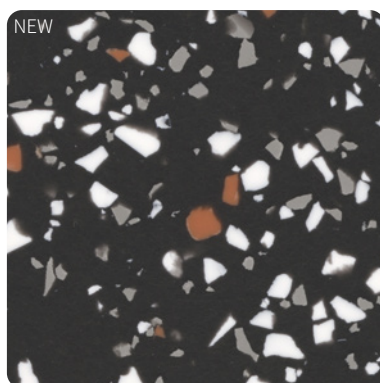

Terrazzo Nocturn | GCT 162

# Veneto



Marmo Sile | GCV 216

In präziser Wertarbeit und mit viel Liebe für das Detail entstehen Veneto-Dekore in kleiner Serie – jede Platte für sich ein Unikat. Die ungleichmäßigen Maserungen verleihen dem exklusiven Material seinen einzigartigen Marmorcharakter. Sie können in Intensität und Farbgebung variieren. Verbindungen auf Gehrung ermöglichen ein harmonisches Farbspiel.

Veneto colours are produced in precise, high-class workmanship in small series and with passion for detail – each sheet is a unique item. The veins lend this exclusive material its unique marble nature. They may vary in intensity and highlight seams. Mitre joints provide for a harmonious play of colours.

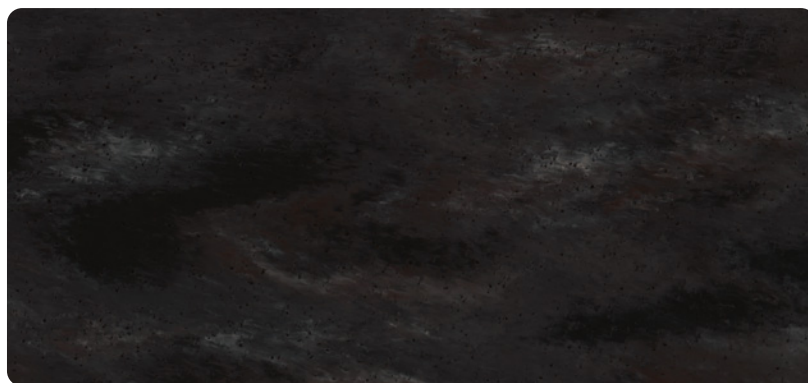

Marmo Meduna | GCV 142





Marmo Padola | GCV 223



Marmo Brenta | GCV 374



Marmo Piave | GCV 239



Marmo Livenza | GCV 478

# 3Deep

Die 3Deep-Technologie verleiht unserem Mineralwerkstoff eine zusätzliche Dimension. Die extreme thermische Verformbarkeit ermöglicht kleinste Radien und maximale Freiheitsgrade in der Gestaltung. Egal, ob filigrane Details im Möbeldesign, oder die individuelle Gestaltung von Modellen wie Waschtischen – tiefgezogen aus einer Platte – oder sogar Badewannen ohne Plattenverklebung: 3Deep macht es möglich.

3Deep gives our solid surface material an additional dimension. Its extreme thermal formability enables minimal radii and maximum design freedom. Whether it's the intricate details of furniture design or the individual composition of pieces such as washstands – deep-drawn from a single sheet – or even bathtubs without panel bonding: 3Deep makes it possible.

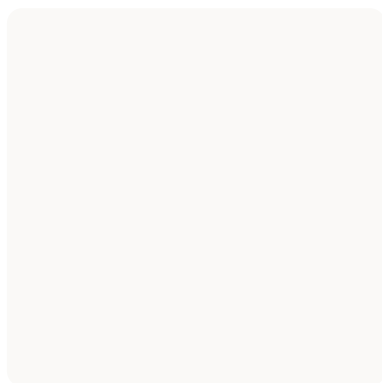

Alaska White | G3D 200

---



# Smart (3 mm)

Code	Name	PG*	4100 mm		2040 mm	
			615 mm	1250 mm	615 mm	1250 mm
			3 mm			
GC1001	Vienna Black	1	•	•	•	•
GC1004	Ascona Grey	1	•	•	•	•
GC1021	Black Eclipse	1	•	•	•	•
GC1104	Concrete Ascona	2	•	•	•	•
GC1112	Frosted Space	2	•	•	•	•
GC1122	Frosted Dark	2	•	•	•	•
GC1472	Miracle Stone	2	•	•	•	•
GC2002	Cream White	0	•	•	•	•
GC2003	Trento White	1	•	•	•	•
GC2007	Pergamon	1	•	•	•	•
GC2008	Davos White	1	•	•	•	•
GC2011	Titan White	0	•	•	•	•
GC2012	Dolomiti White	0	•	•	•	•
GC2042	White Cloud	1	•	•	•	•
GC2245	Frosted Star	2	•	•	•	•
GC2252	Frosted Carat	2	•	•	•	•
GC2258	Miracle Rock	2	•	•	•	•
GC2269	Frosted Cloud	2	•	•	•	•
GC2388	Miracle Beach	2	•	•	•	•
GC3011	Merano Cream	1	•	•	•	•
GC3391	Miracle Dune	2	•	•	•	•
GC3434	Miracle Vanilla	2	•	•	•	•
GC4004	Asphalt Grey	1	•	•	•	•
GC4007	Tessino Grey	1	•	•	•	•
GC4009	Garda Grey	1	•	•	•	•
GC4010	Riva Grey	1	•	•	•	•
GC4012	Lugano Grey	1	•	•	•	•
GC4022	Soho Grey	1	•	•	•	•

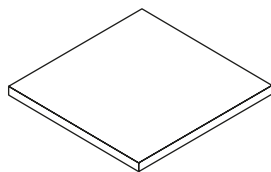

## Smart

Acrylgebundener Mineralwerkstoff nach EN ISO 19712. Oberseite nass geschliffen, Rückseite Trockenschliff. Oberfläche mit Folie geschützt.

Acrylic-resin bound Solid Surface material according to EN ISO 19712, surface wet sanded, reverse side dry sanded, surface foil-protected.

Code	Name	PG*	4100 mm		2040 mm	
			615 mm	1250 mm	615 mm	1250 mm
					3 mm	
GC4143	Frosted Dust	2	•	•	•	•
GC4407	Concrete Tessino	2	•	•	•	•
GC4409	Concrete Garda	2	•	•	•	•
GC4410	Concrete Riva	2	•	•	•	•
GC4412	Concrete Lugano	2	•	•	•	•
GC4439	Miracle Granite	2	•	•	•	•
GC4712	Frosted Grey	2	•	•	•	•
GC4715	Miracle Flint	2	•	•	•	•
GC5012	Megara Green	1	•	•	•	•
GC5021	Vancouver Green	1	•	•	•	•
GC6010	Haddou Red	1	•	•	•	•
GC6021	Almeria Red	1	•	•	•	•
GC8010	Norrebro Blue	1	•	•	•	•
GC8012	Ameti Purple	1	•	•	•	•
GC8021	Tromso Blue	1	•	•	•	•
GC9005	Limana Yellow	1	•	•	•	•
GCT162	Terrazzo Nocturn	3	•	•	•	•
GCT212	Terrazzo Dalmato	3	•	•	•	•
GCT236	Terrazzo Crystal	3	•	•	•	•
GCT244	Terrazzo Pebble	3	•	•	•	•
GCT412	Terrazzo Artico	3	•	•	•	•
GCV142	Marmo Meduna	3	•	•	•	•
GCV216	Marmo Sile	3	•	•	•	•
GCV223	Marmo Padola	3	•	•	•	•
GCV239	Marmo Piave	3	•	•	•	•
GCV374	Marmo Brenta	3	•	•	•	•
GCV478	Marmo Livenza	3	•	•	•	•

# Optimal (10 mm)

Code	Name	PG*	4100 mm		2040 mm	
			615 mm	1250 mm	615 mm	1250 mm
			10 mm			
GC1001	Vienna Black	1	•	•	•	•
GC1004	Ascona Grey	1	•	•	•	•
GC1021	Black Eclipse	1	•	•	•	•
GC1104	Concrete Ascona	2	•	•	•	•
GC1112	Frosted Space	2	•	•	•	•
GC1122	Frosted Dark	2	•	•	•	•
GC1472	Miracle Stone	2	•	•	•	•
GC2002	Cream White	0	•	•	•	•
GC2003	Trento White	1	•	•	•	•
GC2007	Pergamon	1	•	•	•	•
GC2008	Davos White	1	•	•	•	•
GC2011	Titan White	0	•	•	•	•
GC2012	Dolomiti White	0	•	•	•	•
GC2042	White Cloud	1	•	•	•	•
GC2245	Frosted Star	2	•	•	•	•
GC2252	Frosted Carat	2	•	•	•	•
GC2258	Miracle Rock	2	•	•	•	•
GC2269	Frosted Cloud	2	•	•	•	•
GC2388	Miracle Beach	2	•	•	•	•
GC3011	Merano Cream	1	•	•	•	•
GC3391	Miracle Dune	2	•	•	•	•
GC3434	Miracle Vanilla	2	•	•	•	•
GC4004	Asphalt Grey	1	•	•	•	•
GC4007	Tessino Grey	1	•	•	•	•
GC4009	Garda Grey	1	•	•	•	•
GC4010	Riva Grey	1	•	•	•	•
GC4012	Lugano Grey	1	•	•	•	•
GC4022	Soho Grey	1	•	•	•	•

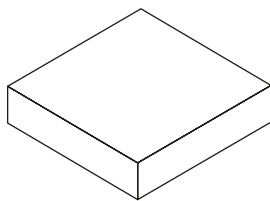

## Optimal

Acrylgebundener Mineralwerkstoff nach EN ISO 19712. Oberseite nass geschliffen, Rückseite Trockenschliff. Oberfläche mit Folie geschützt.

Acrylic-resin bound Solid Surface material according to EN ISO 19712, surface wet sanded, reverse side dry sanded, surface foil-protected.

Code	Name	PG*	4100 mm		2040 mm	
			615 mm	1250 mm	615 mm	1250 mm
			10 mm			
GC4143	Frosted Dust	2	•	•	•	•
GC4407	Concrete Tessino	2	•	•	•	•
GC4409	Concrete Garda	2	•	•	•	•
GC4410	Concrete Riva	2	•	•	•	•
GC4412	Concrete Lugano	2	•	•	•	•
GC4439	Miracle Granite	2	•	•	•	•
GC4712	Frosted Grey	2	•	•	•	•
GC4715	Miracle Flint	2	•	•	•	•
GC5012	Megara Green	1	•	•	•	•
GC5021	Vancouver Green	1	•	•	•	•
GC6010	Haddou Red	1	•	•	•	•
GC6021	Almeria Red	1	•	•	•	•
GC8010	Norrebro Blue	1	•	•	•	•
GC8012	Ameti Purple	1	•	•	•	•
GC8021	Tromso Blue	1	•	•	•	•
GC9005	Limana Yellow	1	•	•	•	•
GCT162	Terrazzo Nocturn	3	•	•	•	•
GCT212	Terrazzo Dalmato	3	•	•	•	•
GCT236	Terrazzo Crystal	3	•	•	•	•
GCT244	Terrazzo Pebble	3	•	•	•	•
GCT412	Terrazzo Artico	3	•	•	•	•
GCV142	Marmo Meduna	3	•	•	•	•
GCV216	Marmo Sile	3	•	•	•	•
GCV223	Marmo Padola	3	•	•	•	•
GCV239	Marmo Piave	3	•	•	•	•
GCV374	Marmo Brenta	3	•	•	•	•
GCV478	Marmo Livenza	3	•	•	•	•

# Classic (6 mm)

Code	Name	PG*	2490 mm	2550 mm
			760 mm	1250 mm
			6 mm	
GC2003	Trento White	1	•	•
GC2008	Davos White	1	•	•
GC2012	Dolomiti White	0	•	•
GC2042	White Cloud	1		•
GC3011	Merano Cream	1	•	•
GC4410	Concrete Riva	2		•
GC4412	Concrete Lugano	2		•
GCV223	Marmo Padola	3		•

# Classic (12 mm)

Code	Name	PG*	3680 mm		
			760 mm	930 mm	1250 mm
			12 mm		
GC1112	Frosted Space	2	•		
GC2003	Trento White	1	•		
GC2007	Pergamon	1	•		
GC2008	Davos White	1	•		
GC2012	Dolomiti White	0	•	•	•
GC2245	Frosted Star	2	•		
GC2252	Frosted Carat	2	•		
GC2258	Miracle Rock	2	•		
GC3011	Merano Cream	2	•		
GC4022	Soho Grey	1	•		
GC4143	Frosted Dust	2	•		
GC4712	Frosted Grey	2	•		

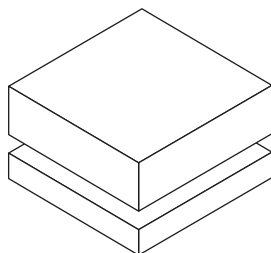

## Classic

Acrylgebundener Mineralwerkstoff nach EN ISO 19712. Oberseite nass geschliffen, Rückseite Trockenschliff. Oberfläche mit Folie geschützt.

Acrylic-resin bound Solid Surface material according to EN ISO 19712, surface wet sanded, reverse side dry sanded, surface foil-protected.



# Classic Extra (20 mm)

Code	Name	PG*	4100 mm		2040 mm	
			615 mm	1250 mm	615 mm	1250 mm
GC2011	Titan White	0	•	•	•	•

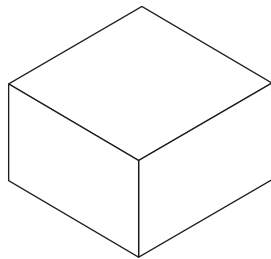

## Classic Extra

Acrylgebundener Mineralwerkstoff nach EN ISO 19712. Oberseite nass geschliffen, Rückseite Trockenschliff. Oberfläche mit Folie geschützt.

Acrylic-resin bound Solid Surface material according to EN ISO 19712, surface wet sanded, reverse side dry sanded, surface foil-protected.

# 3Deep

6 mm

Code	Name	PG*	4100 mm		2040 mm	
			615 mm	1250 mm	615 mm	1250 mm
G3D200	Alaska White	G3D-PG0	•	•	•	•

10 mm

Code	Name	PG*	4100 mm		2040 mm	
			615 mm	1250 mm	615 mm	1250 mm
G3D200	Alaska White	G3D-PG0	•	•	•	•

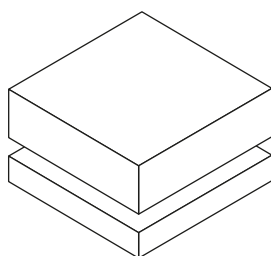

## 3Deep

Acrylgebundener Mineralwerkstoff nach EN ISO 19712. Oberseite nass geschliffen, Rückseite Trockenschliff. Oberfläche mit Folie geschützt.

Acrylic-resin bound Solid Surface material according to EN ISO 19712, surface wet sanded, reverse side dry sanded, surface foil-protected.

# Arbeitsplatten

## Worktops

Code	Name	PG*	Empfehlung für Küche Recommen- dation for kitchen	Einseitig Single postformed			Beidseitig Double postformed		
				4100 mm					
				600 mm	900 mm	1200 mm	670 mm	900 mm	1200 mm
				19,7 mm/28,7 mm/38,3 mm					
GC1001	Vienna Black	1		•	•	•	•	•	•
GC1004	Ascona Grey	1		•	•	•	•	•	•
GC1021	Black Eclipse	1		•	•	•	•	•	•
GC1104	Concrete Ascona	2		•	•	•	•	•	•
GC1112	Frosted Space	2		•	•	•	•	•	•
GC1122	Frosted Dark	2		•	•	•	•	•	•
GC1472	Miracle Stone	2		•	•	•	•	•	•
GC2002	Cream White	0	▲	•	•	•	•	•	•
GC2003	Trento White	1	▲	•	•	•	•	•	•
GC2007	Pergamon	1	▲	•	•	•	•	•	•
GC2008	Davos White	1	▲	•	•	•	•	•	•
GC2011	Titan White	0	▲	•	•	•	•	•	•
GC2012	Dolomiti White	0	▲	•	•	•	•	•	•
GC2042	White Cloud	1	▲	•	•	•	•	•	•
GC2245	Frosted Star	2	▲	•	•	•	•	•	•
GC2252	Frosted Carat	2	▲	•	•	•	•	•	•
GC2258	Miracle Rock	2	▲	•	•	•	•	•	•
GC2269	Frosted Cloud	2	▲	•	•	•	•	•	•
GC2388	Miracle Beach	2	▲	•	•	•	•	•	•
GC3011	Merano Cream	1	▲	•	•	•	•	•	•
GC3391	Miracle Dune	2	▲	•	•	•	•	•	•
GC3434	Miracle Vanilla	2	▲	•	•	•	•	•	•
GC4004	Asphalt Grey	1	▲	•	•	•	•	•	•
GC4007	Tessino Grey	1		•	•	•	•	•	•
GC4009	Garda Grey	1		•	•	•	•	•	•
GC4010	Riva Grey	1	▲	•	•	•	•	•	•
GC4012	Lugano Grey	1	▲	•	•	•	•	•	•
GC4022	Soho Grey	1	▲	•	•	•	•	•	•

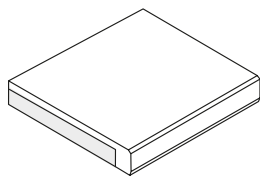

### Arbeitsplatten 19,7 mm/28,7 mm

16/25 mm Qualitätspanplattenträger Typ P2 nach EN 312, Oberseite mit Getacore Smart (3 mm) belegt, nass geschliffen. Unterseite 0,7 mm Gegenzug, Vorderkante Getacore 10 mm. Oberfläche mit Folie geschützt.

### Worktops 19.7 mm/28.7 mm

16/25 mm chipboard type P2 according to EN 312, faced with Getacore Smart (3 mm), wet sanded. Reverse side with 0.7 mm balancer, front edge 10 mm Getacore. Moisture-resistant seal at Getacore/balancer joint. Surface foil-protected.

Code	Name	PG*	Empfehlung für Küche Recommen- dation for kitchen	Einseitig Single postformed			Beidseitig Double postformed		
				4100 mm					
				600 mm	900 mm	1200 mm	670 mm	900 mm	1200 mm
				19,7 mm/28,7 mm/38,3 mm					
GC4143	Frosted Dust	2	▲	•	•	•	•	•	•
GC4407	Concrete Tessino	2		•	•	•	•	•	•
GC4409	Concrete Garda	2	▲	•	•	•	•	•	•
GC4410	Concrete Riva	2	▲	•	•	•	•	•	•
GC4412	Concrete Lugano	2	▲	•	•	•	•	•	•
GC4439	Miracle Granite	2	▲	•	•	•	•	•	•
GC4712	Frosted Grey	2		•	•	•	•	•	•
GC4715	Miracle Flint	2		•	•	•	•	•	•
GC5012	Megara Green	1		•	•	•	•	•	•
GC5021	Vancouver Green	1		•	•	•	•	•	•
GC6010	Haddou Red	1		•	•	•	•	•	•
GC6021	Almeria Red	1		•	•	•	•	•	•
GC8010	Norrebro Blue	1		•	•	•	•	•	•
GC8012	Ameti Purple	1		•	•	•	•	•	•
GC8021	Tromso Blue	1		•	•	•	•	•	•
GC9005	Limana Yellow	1		•	•	•	•	•	•
GCT162	Terrazzo Nocturn	3		•	•	•	•	•	•
GCT212	Terrazzo Dalmato	3	▲	•	•	•	•	•	•
GCT236	Terrazzo Crystal	3	▲	•	•	•	•	•	•
GCT244	Terrazzo Pebble	3	▲	•	•	•	•	•	•
GCT412	Terrazzo Artico	3	▲	•	•	•	•	•	•
GCV142	Marmo Meduna	3		•	•	•	•	•	•
GCV216	Marmo Sile	3	▲	•	•	•	•	•	•
GCV223	Marmo Padola	3	▲	•	•	•	•	•	•
GCV239	Marmo Piave	3	▲	•	•	•	•	•	•
GCV374	Marmo Brenta	3	▲	•	•	•	•	•	•
GCV478	Marmo Livenza	3	▲	•	•	•	•	•	•

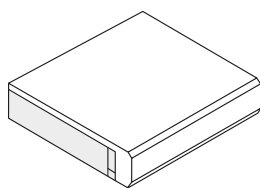

### Arbeitsplatten 38,3 mm

35 mm Qualitätsspanplattenträger Typ P3 nach EN 312, Oberseite mit Getacore Smart (3 mm) belegt, nass geschliffen. Unterseite 0,3 mm Gegenzug, Vorderkante Getacore 10 mm mit Dehnungsfuge. Stoßstelle Getacore/Gegenzug feuchtebeständig versiegelt. Oberfläche mit Folie geschützt.

### Worktops 38.3 mm

35 mm chipboard Type P3 according to EN 312, faced with Getacore Smart (3 mm), wet sanded. Reverse side with 0.3 mm balancer, front edge 10 mm Getacore with an elastic expansion joint. Moisture-resistant seal at Getacore/balancer joint. Surface foil-protected.

# Verbundelemente

## Compound elements

Code	Name	PG*	A/A-Qualität (Gesamtdicke) A/A Quality (total thickness)				A/C-Qualität (Gesamtdicke) A/A Quality (total thickness)			
			4100 mm							
			1250 mm							
			22 mm	24 mm	31 mm	41 mm	21,7 mm	28,7 mm	38,7 mm	
GC1001	Vienna Black	1	•	•	•	•	•	•	•	
GC1004	Ascona Grey	1	•	•	•	•	•	•	•	
GC1021	Black Eclipse	1	•	•	•	•	•	•	•	
GC1104	Concrete Ascona	2	•	•	•	•	•	•	•	
GC1112	Frosted Space	2	•	•	•	•	•	•	•	
GC1122	Frosted Dark	2	•	•	•	•	•	•	•	
GC1472	Miracle Stone	2	•	•	•	•	•	•	•	
GC2002	Cream White	0	•	•	•	•	•	•	•	
GC2003	Trento White	1	•	•	•	•	•	•	•	
GC2007	Pergamon	1	•	•	•	•	•	•	•	
GC2008	Davos White	1	•	•	•	•	•	•	•	
GC2011	Titan White	0	•	•	•	•	•	•	•	
GC2012	Dolomiti White	0	•	•	•	•	•	•	•	
GC2042	White Cloud	1	•	•	•	•	•	•	•	
GC2245	Frosted Star	2	•	•	•	•	•	•	•	
GC2252	Frosted Carat	2	•	•	•	•	•	•	•	
GC2258	Miracle Rock	2	•	•	•	•	•	•	•	
GC2269	Frosted Cloud	2	•	•	•	•	•	•	•	
GC2388	Miracle Beach	2	•	•	•	•	•	•	•	
GC3011	Merano Cream	1	•	•	•	•	•	•	•	
GC3391	Miracle Dune	2	•	•	•	•	•	•	•	
GC3434	Miracle Vanilla	2	•	•	•	•	•	•	•	
GC4004	Asphalt Grey	1	•	•	•	•	•	•	•	
GC4007	Tessino Grey	1	•	•	•	•	•	•	•	
GC4009	Garda Grey	1	•	•	•	•	•	•	•	
GC4010	Riva Grey	1	•	•	•	•	•	•	•	
GC4012	Lugano Grey	1	•	•	•	•	•	•	•	
GC4022	Soho Grey	1	•	•	•	•	•	•	•	

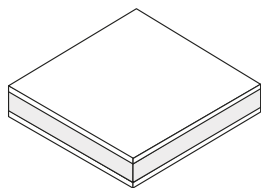

### Verbundelemente Typ A/A

16/18/25/35 mm Qualitätsspanplattenträger nach EN 312, Kanten unbesäumt, Vorder- und Rückseite Getacore Smart (3 mm), Oberfläche Nassschliff.

### Compound elements type A/A

16/18/25/35 mm Quality chipboard according to EN 312, untrimmed edges, both sides Getacore Smart (3 mm), wet sanded surface.

Code	Name	PG*	A/A-Qualität (Gesamtdicke) A/A Quality (total thickness)				A/C-Qualität (Gesamtdicke) A/A Quality (total thickness)			
			4100 mm							
			1250 mm							
			22 mm	24 mm	31 mm	41 mm	21,7 mm	28,7 mm	38,7 mm	
GC4143	Frosted Dust	2	•	•	•	•	•	•	•	
GC4407	Concrete Tessino	2	•	•	•	•	•	•	•	
GC4409	Concrete Garda	2	•	•	•	•	•	•	•	
GC4410	Concrete Riva	2	•	•	•	•	•	•	•	
GC4412	Concrete Lugano	2	•	•	•	•	•	•	•	
GC4439	Miracle Granite	2	•	•	•	•	•	•	•	
GC4712	Frosted Grey	2	•	•	•	•	•	•	•	
GC4715	Miracle Flint	2	•	•	•	•	•	•	•	
GC5012	Megara Green	1	•	•	•	•	•	•	•	
GC5021	Vancouver Green	1	•	•	•	•	•	•	•	
GC6010	Haddou Red	1	•	•	•	•	•	•	•	
GC6021	Almeria Red	1	•	•	•	•	•	•	•	
GC8010	Norrebro Blue	1	•	•	•	•	•	•	•	
GC8012	Ameti Purple	1	•	•	•	•	•	•	•	
GC8021	Tromso Blue	1	•	•	•	•	•	•	•	
GC9005	Limana Yellow	1	•	•	•	•	•	•	•	
GCT162	Terrazzo Nocturn	3	•	•	•	•	•	•	•	
GCT212	Terrazzo Dalmato	3	•	•	•	•	•	•	•	
GCT236	Terrazzo Crystal	3	•	•	•	•	•	•	•	
GCT244	Terrazzo Pebble	3	•	•	•	•	•	•	•	
GCT412	Terrazzo Artico	3	•	•	•	•	•	•	•	
GCV142	Marmo Meduna	3	•	•	•	•	•	•	•	
GCV216	Marmo Sile	3	•	•	•	•	•	•	•	
GCV223	Marmo Padola	3	•	•	•	•	•	•	•	
GCV239	Marmo Piave	3	•	•	•	•	•	•	•	
GCV374	Marmo Brenta	3	•	•	•	•	•	•	•	
GCV478	Marmo Livenza	3	•	•	•	•	•	•	•	

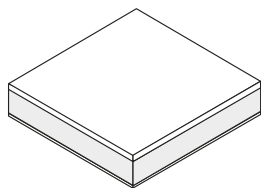

#### Verbundelemente Typ A/C

18/25/35 mm Qualitätsspanplattenträger nach EN 312, Kanten unbesäumt, Vorderseite Getacore Smart (3 mm), Oberfläche Nassschliff, Rückseite Getalit HPL 0,7 mm.

#### Compound elements type A/C

18/25/35 mm quality chipboard according to EN 312, untrimmed edges, front side Getacore Smart (3 mm), wet sanded surface. Reverse side Getalit HPL 0.7 mm.

# Elementezubehör

## Accessories for elements

Code	Name	PG*	Kanten Edges		Wandanschluss Wall splashback	Hohlkehle Coved upstand
			4100 mm			
			45 mm		34 mm	18 mm
			3 mm	10 mm	10 mm	
GC1001	Vienna Black	1	•	•	•	•
GC1004	Ascona Grey	1	•	•	•	•
GC1021	Black Eclipse	1	•	•	•	•
GC1104	Concrete Ascona	2	•	•	•	•
GC1112	Frosted Space	2	•	•	•	•
GC1122	Frosted Dark	2	•	•	•	•
GC1472	Miracle Stone	2	•	•	•	•
GC2002	Cream White	0	•	•	•	•
GC2003	Trento White	1	•	•	•	•
GC2007	Pergamon	1	•	•	•	•
GC2008	Davos White	1	•	•	•	•
GC2011	Titan White	0	•	•	•	•
GC2012	Dolomiti White	0	•	•	•	•
GC2042	White Cloud	1	•	•	•	•
GC2245	Frosted Star	2	•	•	•	•
GC2252	Frosted Carat	2	•	•	•	•
GC2258	Miracle Rock	2	•	•	•	•
GC2269	Frosted Cloud	2	•	•	•	•
GC2388	Miracle Beach	2	•	•	•	•
GC3011	Merano Cream	1	•	•	•	•
GC3391	Miracle Dune	2	•	•	•	•
GC3434	Miracle Vanilla	2	•	•	•	•
GC4004	Asphalt Grey	1	•	•	•	•
GC4007	Tessino Grey	1	•	•	•	•
GC4009	Garda Grey	1	•	•	•	•

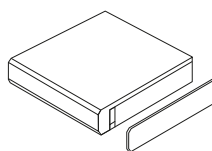

### Kantenmaterial

Getacore in 3 bzw. 10 mm Dicke, Oberfläche nass geschliffen, Rückseite Trockenschliff. Fugenfreies Kleben mit Getacore-Fugenklebstoff.

### Edge material

3 or 10 mm Getacore, surface wet sanded, reverse dry sanded. Concealed fixing by using Getacore two-component adhesive.

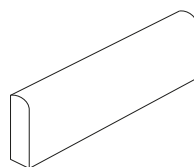

### Wandanschlussprofile

10 mm Getacore mit gerundeter Oberkante, Radius 10 mm, Oberfläche nass geschliffen, Rückseite Trockenschliff.

### Wall splashback profiles

10 mm Getacore with rounded front edge, radius 10 mm, surface: wet sanded, reverse dry sanded.

Code	Name	PG*	Kanten Edges		Wandanschluss Wall splashback	Hohlkehle Coved upstand
			4100 mm			
			45 mm		34 mm	18 mm
			3 mm	10 mm	10 mm	
GC4010	Riva Grey	1	•	•	•	•
GC4012	Lugano Grey	1	•	•	•	•
GC4022	Soho Grey	1	•	•	•	•
GC4143	Frosted Dust	2	•	•	•	•
GC4407	Concrete Tessino	2	•	•	•	•
GC4409	Concrete Garda	2	•	•	•	•
GC4410	Concrete Riva	2	•	•	•	•
GC4412	Concrete Lugano	2	•	•	•	•
GC4439	Miracle Granite	2	•	•	•	•
GC4712	Frosted Grey	2	•	•	•	•
GC4715	Miracle Flint	2	•	•	•	•
GC5012	Megara Green	1	•	•	•	•
GC5021	Vancouver Green	1	•	•	•	•
GC6010	Haddou Red	1	•	•	•	•
GC6021	Almeria Red	1	•	•	•	•
GC8010	Norrebro Blue	1	•	•	•	•
GC8012	Ameti Purple	1	•	•	•	•
GC8021	Tromso Blue	1	•	•	•	•
GC9005	Limana Yellow	1	•	•	•	•
GCT162	Terrazzo Nocturn	3	•	•	•	•
GCT212	Terrazzo Dalmato	3	•	•	•	•
GCT236	Terrazzo Crystal	3	•	•	•	•
GCT244	Terrazzo Pebble	3	•	•	•	•
GCT412	Terrazzo Artico	3	•	•	•	•
GCV142	Marmo Meduna	3	•	•	•	•
GCV216	Marmo Sile	3	•	•	•	•
GCV223	Marmo Padola	3	•	•	•	•
GCV239	Marmo Piave	3	•	•	•	•
GCV374	Marmo Brenta	3	•	•	•	•
GCV478	Marmo Livenza	3	•	•	•	•

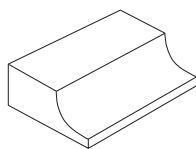

### Hohlkehlenprofile

10 mm Getacore mit Radius 8 mm. Oberfläche nass geschliffen, Rückseite Trockenschliff.  
Für einen formschönen und pflegeleichten Übergang von der Arbeitsplatte zur Wandverkleidung.

### Coved upstand profiles

10 mm Getacore with radius 8 mm. Wet sanded surface finish, reverse side dry sanded.  
Suitable to create a radiused edge between worktop and wallback panel.

# Fugenklebstoff

## Adhesive

Code	Name	Farbe/Colour	50 ml	250 ml
GC1001	Vienna Black	schwarz	•	•
GC1004	Ascona Grey	anthrazitgrau	•	•
GC1021	Black Eclipse	schwarz	•	•
GC1104	Concrete Ascona	anthrazitgrau	•	•
GC1112	Frosted Space	schwarz	•	•
GC1122	Frosted Dark	schwarz	•	•
GC1472	Miracle Stone	schwarz	•	•
GC2002	Cream White	weiß	•	•
GC2003	Trento White	creme	•	•
GC2007	Pergamon	pergamon	•	•
GC2008	Davos White	titanweiß	•	•
GC2011	Titan White	titanweiß	•	•
GC2012	Dolomiti White	schneeweiß	•	•
GC2042	White Cloud	schneeweiß	•	•
GC2245	Frosted Star	titanweiß	•	•
GC2252	Frosted Carat	kieselweiß	•	•
GC2258	Miracle Rock	kieselweiß	•	•
GC2269	Frosted Cloud	titanweiß	•	•
GC2388	Miracle Beach	titanweiß	•	•
GC3011	Merano Cream	elfenbein	•	•
GC3391	Miracle Dune	pergamon	•	•
GC3434	Miracle Vanilla	pergamon	•	•
GC4004	Asphalt Grey	basaltgrau	•	•
GC4007	Tessino Grey	quartzgrau	•	•
GC4009	Garda Grey	zementgrau	•	•
GC4010	Riva Grey	basaltgrau	•	•
GC4012	Lugano Grey	lichtgrau	•	•
GC4022	Soho Grey	nebelgrau	•	•
GC4143	Frosted Dust	mittelgrau	•	•

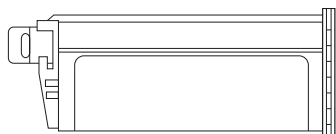

### Fugenklebstoff

Getacore 2-Komponenten-Fugenklebstoff in 50 ml oder 250 ml Kartuschen inkl. 2 Mischerspitzen. Ersatzmischerspitzen sind erforderlich bei mehr als zweimaliger Verwendung derselben Getacore Fugenklebstoff-Kartusche.

### Joint adhesive

Getacore 2-component joint adhesive in 50 ml and 250 ml cartridges including 2 mixing nozzles. Additional nozzles are essential when using the same Getacore cartridge more than twice.



Code	Name	Farbe/Colour	50 ml	250 ml
GC4407	Concrete Tessino	quartzgrau	•	•
GC4409	Concrete Garda	zementgrau	•	•
GC4410	Concrete Riva	basaltgrau	•	•
GC4412	Concrete Lugano	lichtgrau	•	•
GC4439	Miracle Granite	mittelgrau	•	•
GC4712	Frosted Grey	graubraun	•	•
GC4715	Miracle Flint	quartzgrau	•	•
GC5012	Megara Green	salbeigrün	•	•
GC5021	Vancouver Green	waldgrün	•	•
GC6010	Haddou Red	terracotta	•	•
GC6021	Almeria Red	roströt	•	•
GC8010	Norrebro Blue	petrol	•	•
GC8012	Ameti Purple	lavendel	•	•
GC8021	Tromso Blue	tiefseeblau	•	•
GC9005	Limana Yellow	goldgelb	•	•
GCT162	Terrazzo Nocturn	anthrazitgrau	•	•
GCT212	Terrazzo Dalmato	pergamon	•	•
GCT236	Terrazzo Crystal	titanweiß	•	•
GCT244	Terrazzo Pebble	kieselweiß	•	•
GCT412	Terrazzo Artico	basaltgrau	•	•
GCV142	Marmo Meduna	schwarz	•	•
GCV216	Marmo Sile	weiß	•	•
GCV223	Marmo Padola	titanweiß	•	•
GCV239	Marmo Piave	pergamon	•	•
GCV374	Marmo Brenta	weiß	•	•
GCV478	Marmo Livenza	nebelgrau	•	•

# Zubehör

## Accessories

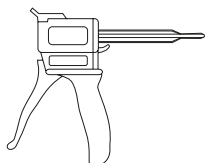

### Spezialklebepistole

für Getacore 2-Komponenten-Fugenklebstoff. Für System 50 ml oder System 250 ml. Ersatzmischerspitzen sind erforderlich bei mehr als zweimaliger Verwendung derselben Getacore Fugenklebstoff-Kartusche.

### Special adhesive gun

for Getacore 2-component joint adhesive. Suitable for systems 50 ml or 250 ml. Additional nozzles are essential when using the same Getacore cartridge more than twice.

Spezialklebepistole/Special adhesive gun	1 Stück/piece
klein/small	420 000
groß (Kunststoff)/large (plastic)	420 006
groß (Metall)/large (metal)	835 531



### Ersatzmischerspitzen

für 50/250 ml Kartuschen. Ersatzmischerspitzen sind erforderlich bei mehr als zweimaliger Verwendung derselben Getacore Kartusche.

### Replacement nozzles

for 50/250 ml cartridges. Additional nozzles are essential when using the same Getacore cartridge more than twice.

Ersatzmischerspitzen/Replacement nozzles	10 Stück/pieces
klein/small	420 005
groß/large	610 601

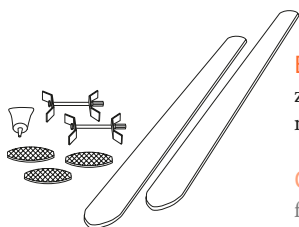

### Eckverbindungsset

zur einfachen und qualitativ hochwertigen Verbindung von Getacore Arbeitsplatten mit Qualitätsspanplattenträger.

### Corner joint set

for a simple and high-quality joint between Getacore worktops with a chipboard substrate.

Eckverbindungsset/Corner joint set	1 Stück/piece
Inhalt: 2 Getacore-Federn (farblich dem Spanplattenträger angepasst), 2 Satz Arbeitsplattenverbinder bzw. Spannelemente inkl. Lamellos und Weißleim.	562 269
Contents: 2 Getacore tongues (colour-co-ordinated to the chipboard substrate), 2 fixing worktop bonders including lamellos and cold glue.	

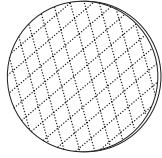

### Schleifpads

zur Oberflächenbearbeitung, kompatibel mit allen handelsüblichen Exzenterschleifmaschinen mit einem Schleiftellerdurchmesser von 150 mm.

### Sanding pads

for surface finishing, compatible with all commercial random orbital sanders with 150 mm sanding plates.

Schleifpads/Sanding pads	1 Stück/piece	25 Stück/pieces
Schleifset Seidenmatt/Edelmatt*/Sanding kit SemiMat/SuperMat*	682 564	
Schleifset Brillantglanz**/Sanding kit HighGloss**	665 787	
Schleifpad P 120/Sanding pad P 120		704 776
Schleifpad P 180/Sanding pad P 180		704 777
Schleifpad P 320/Sanding pad P 320		580 148
Schleifpad P 500/Sanding pad P 500		704 630
Schleifpad P 800/Sanding pad P 800		704 711
Schleifpad P 1200/Sanding pad P 1200		704 712
Schleifpad VF 360 (rot)/Sanding pad VF 360 (red)		704 628
Schleifpad S 400 (schwarz)/Sanding pad S 400 (black)		704 629
Staubpad STS 150/Dust pad STS 150		580 152
Filzpad/Felt pad		602 925

\* Inhalt/Contents: 2×P 120, 2×P 180, 2×P 320, 2×VF 360 (rot/ red), 2×S 400 (schwarz/black), 1×STS 150

\*\* Inhalt/Contents: 2×P 120, 2×P 180, 2×P 320, 2×P 500, 2×P 800, 2×P 1200, 1×STS 150, 1×Filzpad/Felt pad

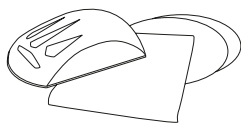

### Pflegeset

in kleiner und großer Ausführung für Getacore Oberflächen.

### Care and maintenance kit

in small and large version for Getacore surfaces.

Pflegeset/Care & Maintenance kit	1 Stück/piece
Pflegeset klein – Inhalt: je 1×Mikrofasertuch, Schleifklotz, Schleifpad P 320, P 800, S 400, Staubpad STS 150, Finishing-Schwamm	618 291
Care & Maintenance set small – Contents: 1 piece each of microfibre-cloth, sanding block, sanding pad P 320, P 800, S 400, dust pad STS 150, finishing sponge	
Pflegeset groß – Inhalt: je 1×Mikrofasertuch, Schleifklotz, Schleifpad P 320, P 800, S 400, Staubpad STS 150, Finishing-Schwamm, Schleifset Brillantglanz, Poliermilch, Cleaner	618 280
Care and Maintenance set large – Contents: 1 piece each of microfibre-cloth, sanding block, sanding pad P 320, P 800, S 400, dust pad STS 150, finishing sponge, HighGloss sanding set, polishing milk, cleaner	

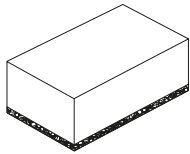

**Finishingschwamm**

zur Beseitigung von Gebrauchsspuren. Geeignet für alle Getacore Flächen im Endfinish „Seidenmatt“.

**Finishing sponge**

to remove marks of wear and tear. Appropriate for all Getacore surfaces with “Semi-Mat” finish.

Finishingschwamm/Finishing sponge	1 Stück/piece	24 Stück/pieces
Oberfläche Seidenmatt/End finish SemiMat	705 440	706 737



**Cleaner**

Spezialreiniger für alle Getacore Oberflächen zur Entfernung von hartnäckigen Flecken, wie z.B. Kaffee, Tee, etc. Inhalt: 500 ml

Special cleaner for all Getacore surfaces to remove heavy stains, like e.g. coffee, tea, etc. Contents 500 ml



**Poliermilch**

Festool Poliermilch (Inhalt 500 ml) zum Erzielen des Oberflächenfinish „Brillantglanz“.

**Polish milk**

Festool polish milk (contents 500 ml) to achieve the “HighGloss” surface finish.

Cleaner	1 Stück/piece	12 Stück/pieces
500 ml	570 855	577 982

Poliermilch/Polish milk	1 Stück/piece
500 ml	705 593

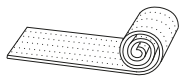

**Korkstreifen**

als elastisches Dehnungsfugenmaterial zur Montage des 10 mm Kantenmaterials.

**Cork strip**

as an elastic expansion joint material to mount the 10 mm edge material.

Korkstreifen/Cork strip	1 Stück/piece
1800×35×5 mm	577 626
19000×35×5 mm	612 288

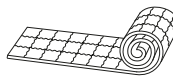

**Thermoband**

zur fachgerechten Isolierung von Herdausschnitten.

**Thermo strip**

for professional isolation of cut outs for cookers/ovens.

Thermoband/Thermo strip	1 Stück/piece
5000×25×2 mm	nicht klebend / non adhesive 584 834
10000×25×2 mm	nicht klebend / non adhesive 582 867
5000×25×2 mm	selbstklebend / self-adhesive 802 648

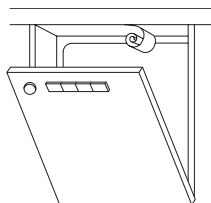

**Alu Klebefolie**

zum Schutz der vorderen Arbeitsplattenunterseite im Bereich von Backöfen und Geschirrpülern, sowie von Flächenausschnitten.

**Alu steam protection foil**

to protect the front underside of worktops in the area of ovens and dishwashers, as well as surface cut-outs.

Alu Klebefolie/Alu steam protection foil	1 Stück/piece
1000×75×0,3 mm	427 800
5000×75×0,3 mm	608 681

# Zuschnitt

Cut-to-size

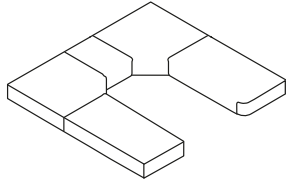

Alle Arbeitsplattendekore sind auch konfektioniert lieferbar.  
Nutzen Sie den Service z. B. für den dekorgleichen Beckeneinbau.

All worktop decors are also available as cut-to-size. Benefit from this service, for example for sink/basin installation in same colour.

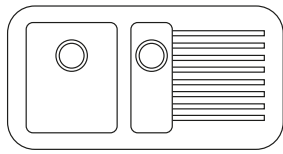

Spülenmodule (mit Abtropfrillen) in Kombination mit verschiedensten Spülenvarianten sind Bestandteil der Getacore-Zuschnittpreisliste.

Sink modules (with drainer area) in combination with different sink versions are part of the Getacore cut-to-size price list.

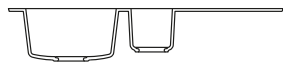

# Spülen und Becken

## Sinks and Basins

Leicht zu reinigen, hygienisch und mit einer angenehmen Haptik: Getacore beweist als Spüle, Sanitärbecken und konfektionierter Waschtisch seine Qualitäten. Die klare Formensprache wertet Küchen und Bäder auf – sowohl im privaten Wohnraum als auch in Objekten.

Easy to clean, hygienic and pleasant to the touch: the proven quality of Getacore lends itself to sinks, sanitary basins and pre-assembled washstands. The clean design language elevates the design of kitchen and bathrooms, both in private homes and commercial spaces.



# Küchenspülen

Kitchen sinks

GC-MK-190

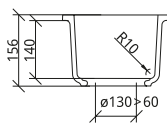
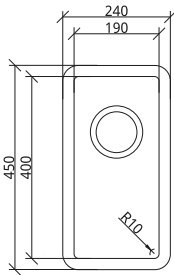

GC-MK-330

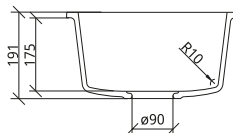
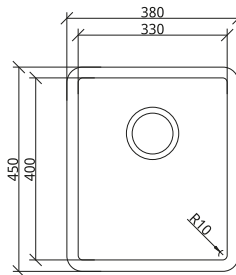

GC-MK-400

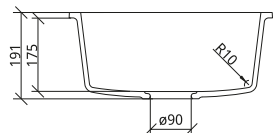
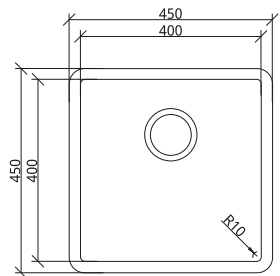



GC-MK-450



GC-MK-500

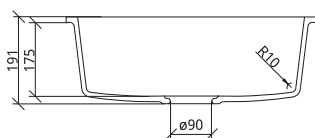
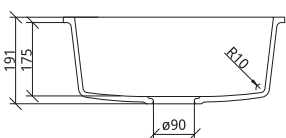
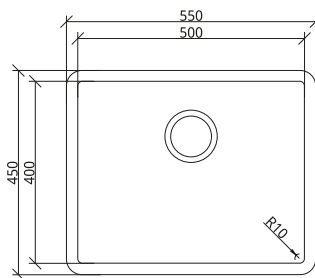
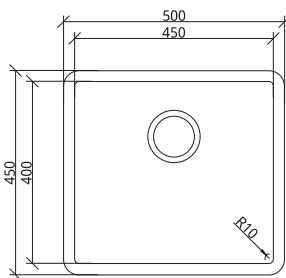
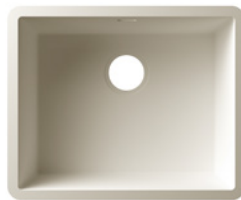

Model	Code	Überlauf Overflow	Zubehör Accessories
GC-MK-190	GC 2012 *	nur mit only with	inkl. Dichtungsmanschetten, Ab- und Überlaufgarnitur mit Handbetätigung und Geruchsverschluss incl. sealing rubber sleeves, manual downpipe and overflow set and odour lock
GC-MK-330	GC 2012 *	nur mit only with	inkl. Dichtungsmanschetten, Ab- und Überlaufgarnitur mit Drehknopfexzenter und Geruchsverschluss incl. sealing rubber sleeves, downpipe and overflow set with eccentric rotary knot and odour lock
GC-MK-400			
GC-MK-450			
GC-MK-500			

\* kann farblich abweichen / colour deviation possible

# Küchenspülen mit Edelstahlboden

Kitchen sinks with stainless steel bottom

GC-KE-300

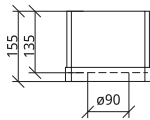
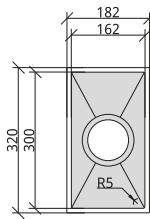

GC-KE-418

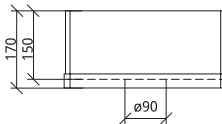
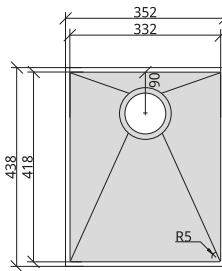

GC-KE-450

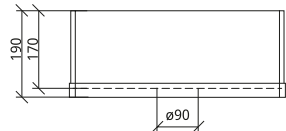
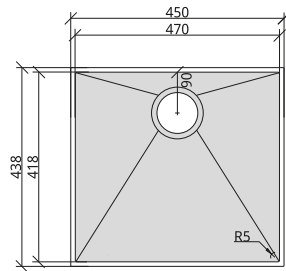

GC-KE-480

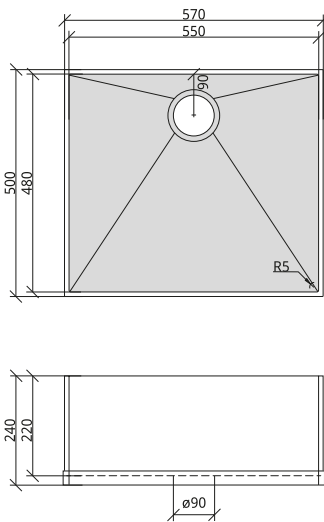

GC-KE-345

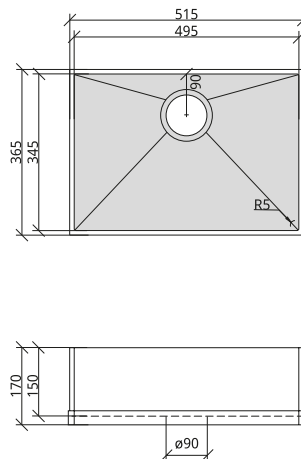

GC-AE-345

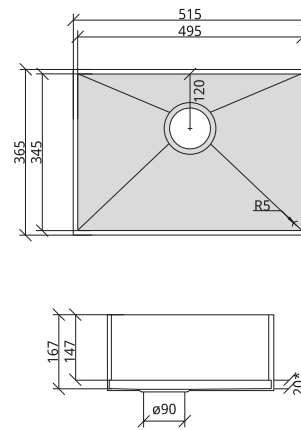

\*20 mm Aufkantung (Edelstahl)  
\*20 mm upstand (stainless steel)

Model	Code	Überlauf Overflow	Zubehör Accessories
GC-KE-300	Colour Palette	mit oder ohne with or without	inkl. Dichtungsmanschetten, bei Überlaufbohrung: inkl. Ab- und Überlaufgarnitur mit Handbetätigung und Geruchsverschluss incl. sealing rubber sleeves, for overflow drilling: incl. manual downpipe and overflow set and odour lock
GC-KE-418			
GC-KE-450			
GC-KE-480	Colour Palette	mit oder ohne with or without	inkl. Dichtungsmanschetten, bei Überlaufbohrung: inkl. Ab- und Überlaufgarnitur mit Drehknopfexzenter und Geruchsverschluss incl. sealing rubber sleeves, for overflow drilling: incl. downpipe and overflow set with eccentric rotary knot and odour lock
GC-KE-345			
GC-AE-345			

# Sanitärbecken als Aufsatz

Top-mounted bathroom basins

GC-AR-500

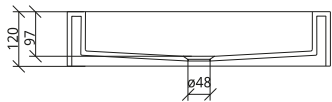
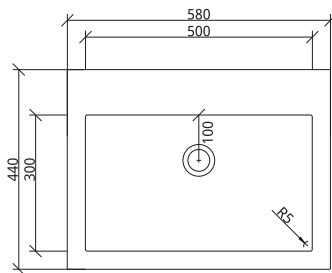

GC-AW-600

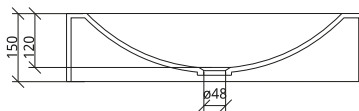
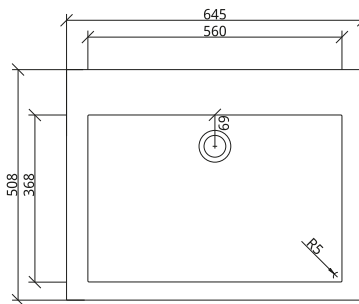

GC-OA-650

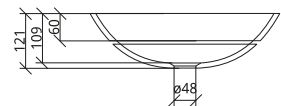
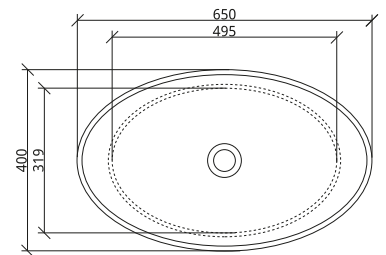

Model	Code	Überlauf Overflow	Zubehör Accessories
GC-AR-500	Colour Palette	mit oder ohne with or without	inkl. Dichtungsmanschetten, bei Überlaufbohrung: inkl. montierter Überlaufgarnitur
GC-AW-600			incl. sealing rubber sleeves, for overflow drilling: incl. installed overflow
GC-OA-650	Colour Palette	nur mit only with	inkl. Dichtungsmanschetten incl. sealing rubber sleeves

# Sanitärbecken als Unterbau

Undermounted bathroom basins

GC-SP-400

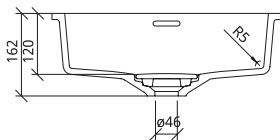
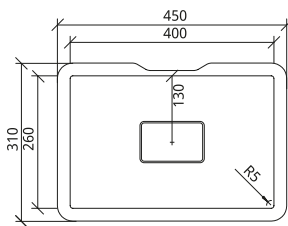

GC-SP-500

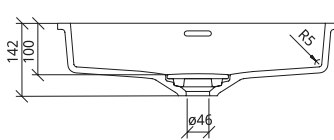
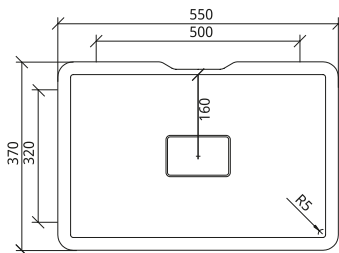

Model	Code	Überlauf Overflow	Zubehör Accessories
GC-SP-400	GC 2012 *	mit oder ohne with or without	inkl. Dichtungsmanschetten, bei Überlaufbohrung: inkl. montierter
GC-SP-500			Überlaufgarnitur, mit verdecktem Ablauf incl. sealing rubber sleeves, for overflow drilling: incl. installed overflow, with covered drain

\* kann farblich abweichen / colour deviation possible

GC-SR-400

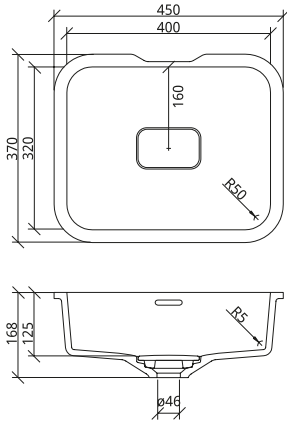

GC-SR-500

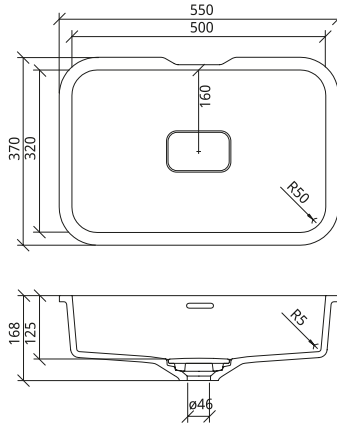

GC-SF-400

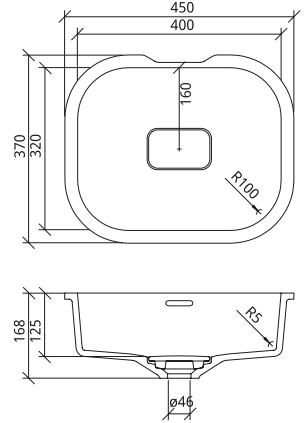

GC-SF-500

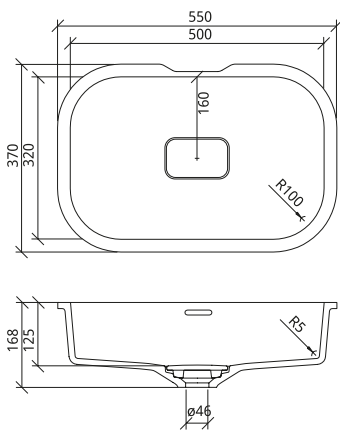

GC-SM-400

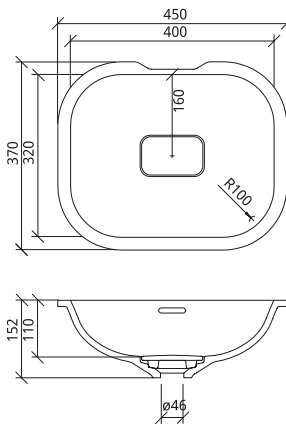

GC-SM-500

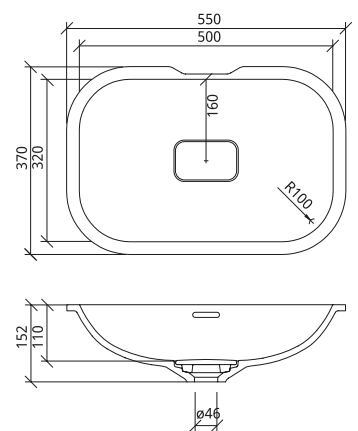

GC-RG-400

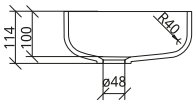
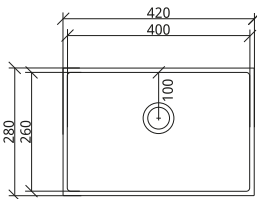

GC-RG-450

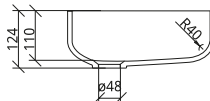
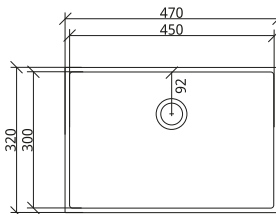

GC-RG-550

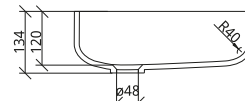
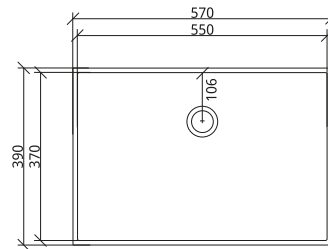

Model	Code	Überlauf Overflow	Zubehör Accessories
GC-SR-400	GC 2012 *	mit oder ohne with or without	inkl. Dichtungsmanschetten, bei Überlaufbohrung: inkl. montierter Überlaufgarnitur, mit verdecktem Ablauf incl. sealing rubber sleeves, for overflow drilling: incl. installed overflow, with covered drain
GC-SR-500			
GC-SF-400			
GC-SF-500			
GC-SM-400			
GC-SM-500	Colour Palette	mit oder ohne with or without	inkl. Dichtungsmanschetten, bei Überlaufbohrung: inkl. montierter Überlaufgarnitur incl. sealing rubber sleeves, for overflow drilling: incl. installed overflow
GC-RG-400			
GC-RG-450			
GC-RG-550			

\* kann farblich abweichen / colour deviation possible

GC-RE-330

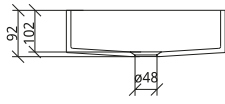
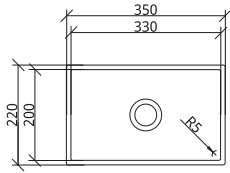

GC-RE-400

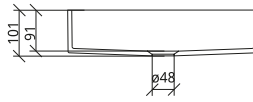
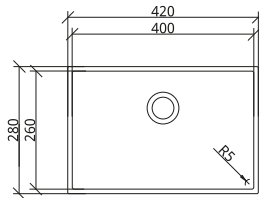

GC-RE-500

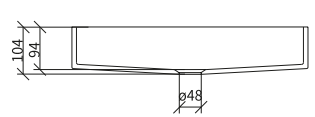
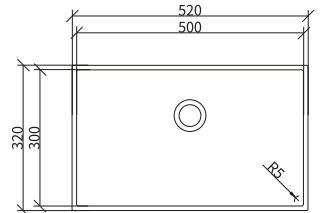

GC-RE-550

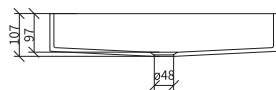
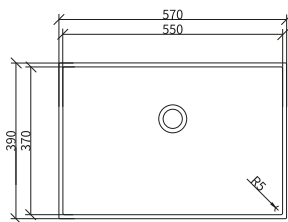

GC-W-460

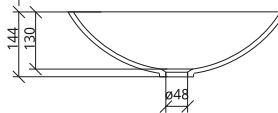
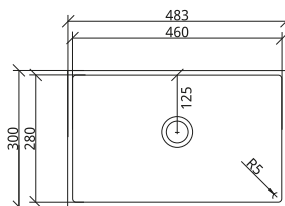

GC-W-600

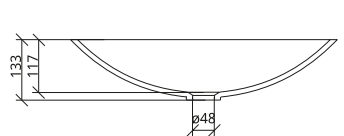
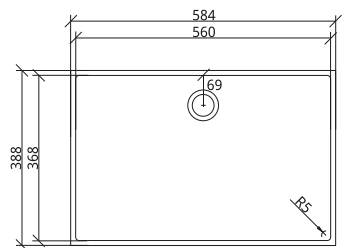



## GC-W-1000

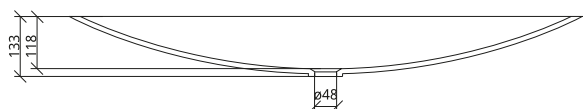
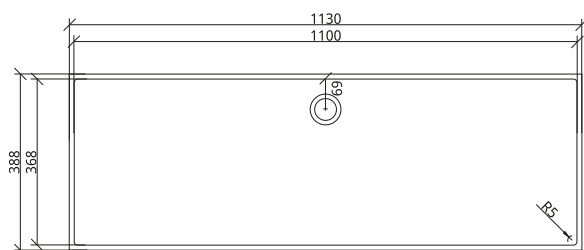

Model	Code	Überlauf Overflow	Zubehör Accessories
GC-RE-330			
GC-RE-400			
GC-RE-500	Colour Palette	mit oder ohne with or without	inkl. Dichtungsmanschetten, bei Überlaufbohrung: inkl. montierter Überlaufgarnitur incl. sealing rubber sleeves, for overflow drilling: incl. installed overflow
GC-RE-550			
GC-W-460			
GC-W-600			
GC-W-1000			

GC-RU-275

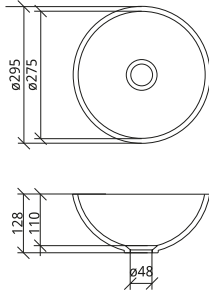

GC-RU-370

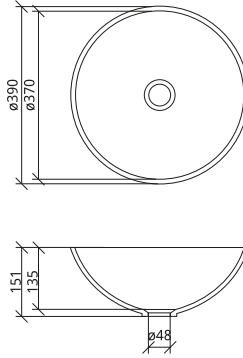

GC-RU-445

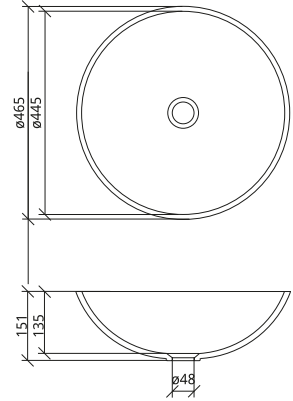

GC-OV-360

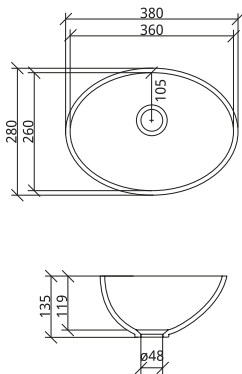

GC-OV-408

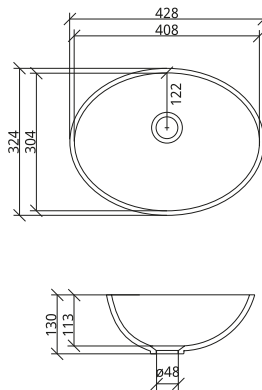

GC-OV-520

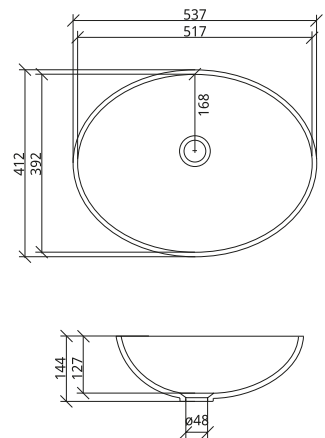

GC-OV-562

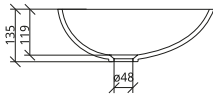
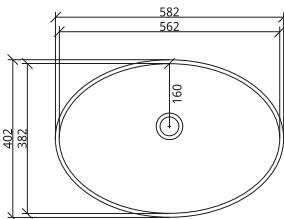

GC-SO-465

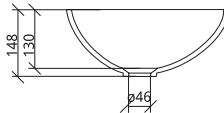
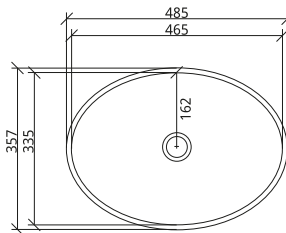

Model	Code	Überlauf Overflow	Zubehör Accessories
GC-RU-275			
GC-RU-370			
GC-RU-445			
GC-OV-360	Colour Palette	mit oder ohne with or without	inkl. Dichtungsmanschetten, bei Überlaufbohrung: inkl. montierter Überlaufgarnitur incl. sealing rubber sleeves, for overflow drilling: incl. installed overflow
GC-OV-408			
GC-OV-520			
GC-OV-562			
GC-SO-465			

# Beckenzubehör

Accessories for sinks and basins



## Silanmodifizierter Polymerklebstoff

Klebstoff zur Befestigung von Edelstahl-Becken an Getacore.  
Kartusche à 310 ml, Farbe: grau.

## Silane-modified polymer glue

Glue to fix stainless steel sinks with Getacore. Cartridge 310 ml.  
Colour: grey.

Silanmodifizierter Polymerklebstoff Silane-modified polymer glue	1 Stück/piece
310 ml	584 203



## Schnellgießharz Biresin

2-Komponenten-PUR-System (à 1 kg), schnell  
härtend, zum rückseitigen Ausgießen von  
Beckenausschnitten, Mischverhältnis 1:1.

## Filling compound Biresin

2-component-system (1 kg each), fast hardening,  
to fill sink/basin cut-outs from the rear end, mixing  
ratio 1:1.

Schnellgießharz Biresin Filling compound Biresin	1 Stück/piece
Set	584 076
Komponente A / Component A	583 980
Komponente B / Component B	583 981



## Dichtungsmanschette

Die Gummimanschette dichtet zuverlässig Bohrungen mit  
einem Durchmesser von 35 mm ab, insbesondere Armatur-  
lochbohrungen in Elementen. Sie schützt das Element (Arbeits-  
platten, Waschtische, etc.) vor Eintritt von Feuchtigkeit und  
verhindert somit Folgeschäden, wie Aufquellen des Span-  
plattenträgers, Risse in der Oberfläche, etc. Je nach der vor-  
liegenden Plattendicke ist die entsprechende Manschette zu  
wählen: Dicke 29 bzw. 39 mm.

## Sealing rubber sleeve

The rubber sleeve safely seals drillings with a diameter of  
35 mm, especially for water-tap drillings in elements. It  
protects the element (worktops, sinks/bowls, etc.) against  
ingress of moisture and by this prevents subsequent damage,  
like chipboard swelling, surface scratches, etc. Depending  
upon the slab's thickness the adequate sleeve has to be chosen:  
thickness 29 or 39 mm.

Dichtungsmanschette Sealing rubber sleeve	1 Stück/piece
29 mm	642 373
39 mm	642 374

## Ablaufsysteme Küchenspülen Downpipe systems for kitchen sinks



mit verchromten Drehknopfexzenter  
Downpipe with eccentric rotary knot



mit Handbetätigung  
Manual downpipe



mit Handbetätigung für Restebecken  
Manual downpipe for left-over sinks



Verbindungsset für Reihenanschluss  
für Getacore Küchenspülen  
Connecting set for serial installation  
for Getacore kitchen sinks



Geruchsverschluss  
Odour lock

Ablaufsysteme Küchenspülen / Downpipe systems for kitchen sinks	1 Stück / piece
mit verchromten Drehknopfexzenter / Downpipe with eccentric rotary knot	561 840
mit Handbetätigung / Manual downpipe	561 841
mit Handbetätigung für Restebecken / Manual downpipe for left-over sinks	561 838
Verbindungsset / Connecting set	561 842
Geruchsverschluss / Odour lock	561 843

## Ablaufsysteme Sanitärbecken Downpipe systems sanitary basins



Waschtischadapter: Überlaufgarnitur  
für Sanitärbecken mit Überlaufbohrung.

Basin adapter: Overflow for sanitary  
basins with overflow drilling.



Clou-Ablaufsystem mit Hebelgestänge  
für Sanitärbecken ohne Überlaufbohrung.

Clou downpipe system with leverage  
for sanitary basins without overflow  
drilling.

Ablaufsysteme Sanitärbecken / Downpipe systems for sanitary basins	1 Stück / piece
Waschtischadapter / Basin adapter	582 570
Clou-Ablaufsystem / Clou downpipe system	547 125

# Objektgeschäft

Custom solutions

Egal ob Hotellobby, Gesundheitszentrum oder Store – Objekte sollen häufig eine unverkennbare Handschrift tragen. Um Farbkonzepte stimmig in Getacore umsetzen zu können, entwickeln wir Dekore nach Kundenwunsch. Darüber hinaus bieten wir individuelle Abmessungen in Länge, Breite und Dicke. Unsere Experten beraten Sie gerne.

Whether it's a hotel lobby, health centre or store – business premises should have a distinctive signature. In order to implement convincing colour concepts in Getacore, we develop decors according to customer requirements. We also offer individual sizes in terms of length, width and thickness. Our experts will be happy to advise you.

## Mögliche Formate

Possible dimensions

Länge/Length: 1800–4100 mm

Breite/Width: 650–1270 mm

Dicke/Thickness: 3–22 mm



# Nachhaltigkeit

## Sustainability

Natürlich gelten bei der Produktion in unserem Werk in Wadersloh strengste europäische Umweltstandards. Doch unser Verständnis von Nachhaltigkeit geht weit über gesetzliche Vorgaben hinaus.

Um uns möglichst umsichtig in unserer Umwelt zu bewegen, setzen wir zum einen auf eine ressourcenschonende Produktion in Deutschland, die auf kurzen und schnellen Lieferwegen CO<sub>2</sub>-Emissionen reduziert. Zum anderen trägt die außergewöhnliche Langlebigkeit unserer Materialien zu einem sparsamen Umgang mit Rohstoffen bei: Sie erlaubt es, Oberflächen neu aufzubereiten, statt sie zu ersetzen.

Zusätzlich verwenden wir bei der Herstellung vieler unserer Produkte recycelte Materialien. Doch unser oberstes Ziel ist es, so wenig Abfall wie möglich zu produzieren. Auch deshalb fertigen wir bei Bedarf Getacore-Platten projektindividuell in der gewünschten Größe und Dicke an. Weil genaues Arbeiten für unsere Kunden weniger Kosten bedeutet und für unsere Umwelt weniger Müll.

It goes without saying that production at our plant in Wadersloh is subject to the strictest European environmental standards. However, our understanding of sustainability goes beyond legal regulations.

In order to leave as little a trace on our environment as possible, we have opted for resource-efficient production in Germany that reduces CO<sub>2</sub> emissions with fast, short delivery distances. What's more, the outstanding durability of our materials helps to conserve resources. It allows surfaces to be renewed, rather than replaced.

We also use recycled materials in the fabrication of many of our products. However, our highest goal is to produce as little waste as possible. That's why, on request, we also manufacture customized Getacore panels in the desired size and thickness. Because precision work means less cost for our customer and less waste for our environment.



Unsere EPDs für dünne Arbeitsplatten und Plattenmaterial finden Sie im Download-Center:  
[www.getacore.com/de/service/#download-center](http://www.getacore.com/de/service/#download-center)

EPDs for thin worktops and sheet material are available in our download centre:  
[www.getacore.com/en/service/#download-center](http://www.getacore.com/en/service/#download-center)

---





## Dekore mit rezykliertem Material Decors with recycled material



Miracle Beach | GC 2388



Frosted Carat | GC 2252

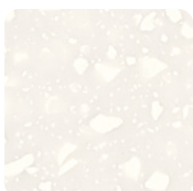

Miracle Rock | GC 2258

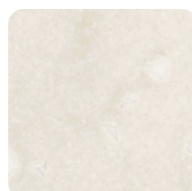

Marmo Piave | GCV 239



Terrazzo Dalmato | GCT 212



Miracle Vanilla | GC 3434



Miracle Dune | GC 3391



Terrazzo Pebble | GCT 244



Terrazzo Artico | GCT 412

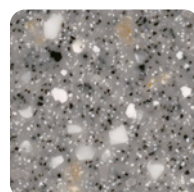

Miracle Granite | GC 4439

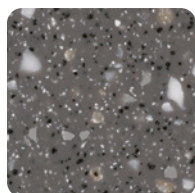

Miracle Flint | GC 4715

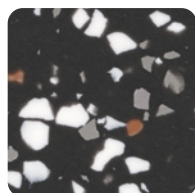

Terrazzo Nocturn | GCT 162

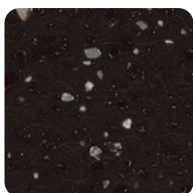

Miracle Stone | GC 1472

# RAL-/NCS- Zuordnung

## RAL/NCS Allocation

Code	Name	RAL*	RAL-Design*	NCS*
GC1001	Vienna Black	80 22		S 8500-N
GC1004	Ascona Grey	70 43	000 35 00	7500-N
GC1021	Black Eclipse		000 25 00	S 8500-N
GC2002	Cream White	90 10		S 0500-N
GC2003	Trento White			S 1002-Y
GC2007	Pergamon	10 13		S 1002-Y50R
GC2008	Davos White	90 03		S 0502-B
GC2011	Titan White	90 16		S 0300-N
GC2012	Dolomiti White	90 16	000 90 00	S 0500-N
GC2042	White Cloud	90 16		S 0500-N
GC3011	Merano Cream	10 13	100 90 05	S 1005-Y10R
GC4004	Asphalt Grey			S 2500-N
GC4007	Tessino Grey	70 39	080 50 05	S 5502-Y
GC4009	Garda Grey	70 37	000 55 00	S 4502-N
GC4010	Riva Grey		000 70 00	S 3500-N
GC4012	Lugano Grey		000 85 00	S 1500-N
GC4022	Soho Grey	70 35		S 2002-G
GC5012	Megara Green		110 70 10	
GC5021	Vancouver Green		180 40 05	S 7005-B80G
GC6010	Haddou Red			S 4030-Y70R
GC6021	Almeria Red		030 30 20	S 6020-Y90R
GC8010	Norrebro Blue		230 50 15	
GC8012	Ameti Purple		290 50 20	
GC8021	Tromso Blue		280 20 15	S 8010-R70B
GC9005	Limana Yellow			S 2030-Y20R

\*Angaben sind Annäherungen an die Farbsysteme und können oberflächenbedingt abweichen.  
Data is approximative with regards to colour systems and may differ depending on surface finishes.



# Anwendung und Pflege

## Use and Care

Der acrylgebundene Mineralwerkstoff Getacore ist für eine lange Lebensdauer ausgelegt. Kratz- und Gebrauchsspuren sind bei einer üblichen Benutzung unvermeidbar und fallen bei hochglänzenden und kräftigen Farben eher auf als bei hellen Dekoren.

### Hitzeschäden vermeiden

Um Hitzeschäden zu vermeiden, stellen Sie heiße Gegenstände und Geräte niemals direkt auf eine Fläche oder ein Becken aus Getacore, sondern auf einen Untersetzer. Wenn Sie kochende Flüssigkeiten (z. B. Kochwasser von Nudeln) in ein Getacore Becken gießen, lassen Sie immer gleichzeitig kaltes Wasser zulaufen, um Temperaturschwankungen zu reduzieren.

### Einfache Reinigung und Auffrischung

Die Pflege der Getacore Oberflächen ist einfach. Schmutz lässt sich leicht mit handelsüblichen Haushaltsreinigern entfernen. Im Gegensatz zu den meisten anderen Materialien können Getacore Oberflächen jederzeit aufgefrischt werden. Leichte Kratz- und Gebrauchsspuren lassen sich einfach entfernen, so dass das Material wieder wie neu aussieht.

Detaillierte Informationen zur Pflege, Auffrischung und Erneuerung von Getacore Oberflächen finden Sie auf [getacore.com](http://getacore.com).

Our Getacore acrylic-bound solid surfaces are designed to be long-lasting solutions. Daily wear and scratches are inevitable through normal use and are more perceptible on high-gloss and bold colours compared to lighter finishes.

### Avoiding heat damage

In order to prevent heat damages on Getacore surface, never put hot pans or other heat sources directly onto a Getacore surface, sink or basin, but place a trivet or a heat protection pad underneath them. When pouring boiling liquids (from boiling pasta, etc.) into a Getacore sink or basin, always pour cold water at the same time to reduce temperature extremes.

### Easy cleaning

Getacore surface maintenance is simple. Dirt may be removed easily using common household cleaning agents. In contrast to most materials, Getacore surfaces may be renewed at any time. Moderate traces of wear and scratches are easily removed to ensure the material maintains its renewed appearance over time.

Detailed information on the care, renovation and renewal of Getacore surfaces is available at [getacore.com](http://getacore.com).



# Über uns

## About us

Getacore ist ein einzigartiger acrylgebundener Mineralwerkstoff, der 2001 auf den Markt gebracht wurde und für seine außergewöhnliche Formstabilität und Langlebigkeit bekannt ist. Entwickelt wurde der Werkstoff von der Westag AG, einem Unternehmen mit über hundertjährigem Know-how in der Fertigung hochwertiger Produkte für den Inneneinrichtungsbereich. Getacore wird exklusiv in einer hochmodernen Produktionsstätte in Nordrhein-Westfalen hergestellt.

Introduced commercially in 2001, Getacore is a unique acrylic-bound solid surface renowned for its exceptional dimensional stability and durability. Developed by Westag AG, a company with over a century of manufacturing know-how in high quality products for interior finishing, Getacore is made exclusively in Germany at its state-of-the-art production facility in North Rhine-Westphalia.

# Kontakt

## Contacts

### Westag AG

Hellweg 15  
33378 Rheda-Wiedenbrück  
Germany

[www.getacore.com](http://www.getacore.com)  
[www.westag.de](http://www.westag.de)

Haftungsausschluss:



[www.westag.de/  
de/unternehmen/  
rechtliches/haftungs-  
ausschluss-1/](http://www.westag.de/de/unternehmen/rechtliches/haftungsausschluss-1/)

Disclaimer:



[www.westag.de/  
en/company/legal/  
disclaimer-1/](http://www.westag.de/en/company/legal/disclaimer-1/)



WESTAG 

MADE IN GERMANY

Westag AG

3-842 875

Hellweg 15  
33378 Rheda-Wiedenbrück  
Germany

09.2022

[www.getacore.com](http://www.getacore.com)  
[www.westag.de](http://www.westag.de)

 **Follow us!**

GETACORE<sup>®</sup>

[getacore.com](http://getacore.com)